

9 Surface Area and Volume

- 9.1 Surface Areas of Prisms
- 9.2 Surface Areas of Pyramids
- 9.3 Surface Areas of Cylinders
- 9.4 Volumes of Prisms
- 9.5 Volumes of Pyramids



"I was thinking that I want the Pagodal roof instead of the Swiss chalet roof for my new doghouse."



"Because PAGODAL rearranges to spell 'A DOG PAL.'"



"Take a deep breath and hold it."



"Now, do you feel like your surface area or your volume is increasing more?"

What You Learned Before

Finding Areas of Squares and Rectangles

Example 1 Find the area of the rectangle.



$$\begin{aligned} \text{Area} &= \ell w \\ &= 7(3) \\ &= 21 \end{aligned}$$

Write formula for area.

Substitute 7 for ℓ and 3 for w .

Multiply.

∴ The area of the rectangle is 21 square millimeters.

Try It Yourself

Find the area of the square or rectangle.

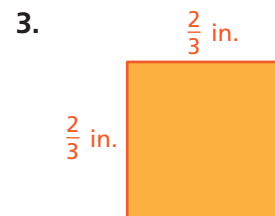
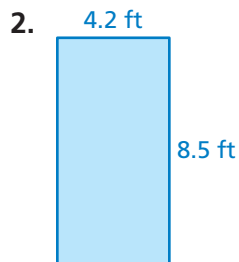
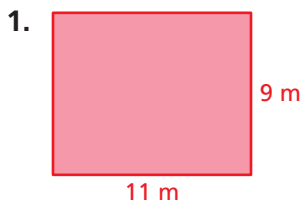

Finding Areas of Triangles

Example 2 Find the area of the triangle.

$$\begin{aligned} A &= \frac{1}{2}bh && \text{Write formula.} \\ &= \frac{1}{2}(6)(7) && \text{Substitute 6 for } b \text{ and 7 for } h. \\ &= \frac{1}{2}(42) && \text{Multiply 6 and 7.} \\ &= 21 && \text{Multiply } \frac{1}{2} \text{ and 42.} \end{aligned}$$

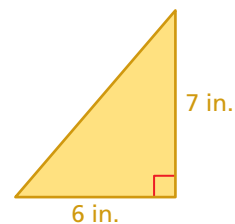

∴ The area of the triangle is 21 square inches.

Try It Yourself

Find the area of the triangle.

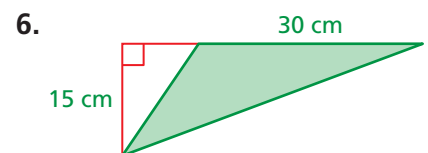
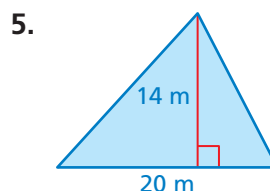
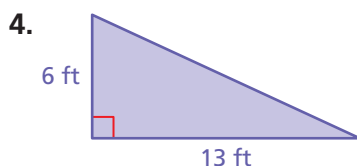

9.1 Surface Areas of Prisms

Essential Question How can you find the surface area of a prism?

1 ACTIVITY: Surface Area of a Rectangular Prism

Work with a partner. Copy the net for a rectangular prism. Label each side as h , w , or l . Then use your drawing to write a formula for the surface area of a rectangular prism.

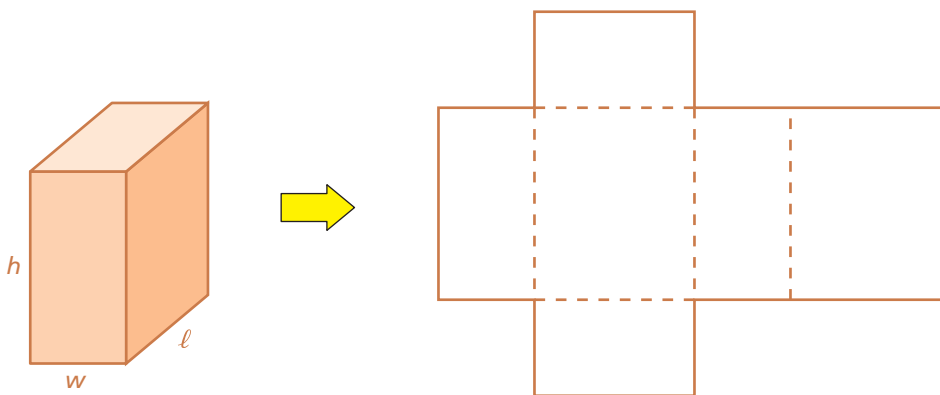

2 ACTIVITY: Surface Area of a Triangular Prism

Work with a partner.

- a. Find the surface area of the solid shown by the net. Copy the net, cut it out, and fold it to form a solid. Identify the solid.

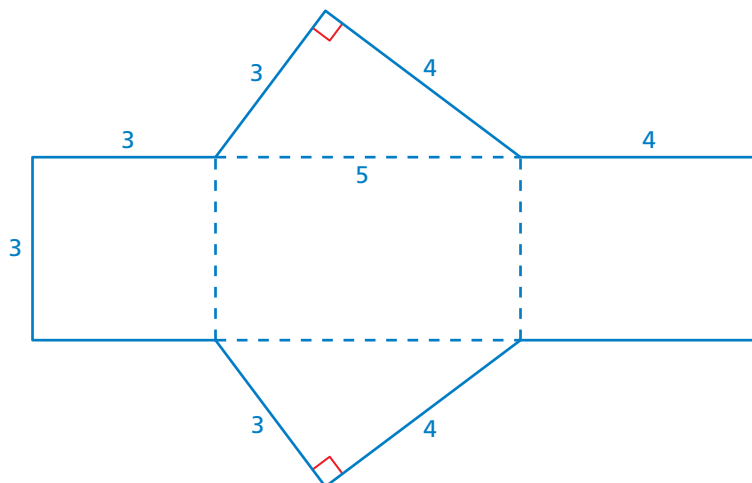

- b. Which of the surfaces of the solid are bases? Why?

Geometry

In this lesson, you will

- use two-dimensional nets to represent three-dimensional solids.
- find surface areas of rectangular and triangular prisms.
- solve real-life problems.

3

ACTIVITY: Forming Rectangular Prisms**Math Practice****Construct Arguments**

What method did you use to find the surface area of the rectangular prism? Explain.

Work with a partner.

- Use 24 one-inch cubes to form a rectangular prism that has the given dimensions.
- Draw each prism.
- Find the surface area of each prism.



a. $4 \times 3 \times 2$

Drawing

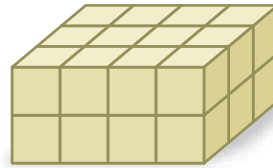

Surface Area

 in.²

b. $1 \times 1 \times 24$

c. $1 \times 2 \times 12$

d. $1 \times 3 \times 8$

e. $1 \times 4 \times 6$

f. $2 \times 2 \times 6$

g. $2 \times 4 \times 3$

What Is Your Answer?

- Use your formula from Activity 1 to verify your results in Activity 3.
- IN YOUR OWN WORDS** How can you find the surface area of a prism?
- REASONING** When comparing ice blocks with the same volume, the ice with the greater surface area will melt faster. Which will melt faster, the bigger block or the three smaller blocks? Explain your reasoning.

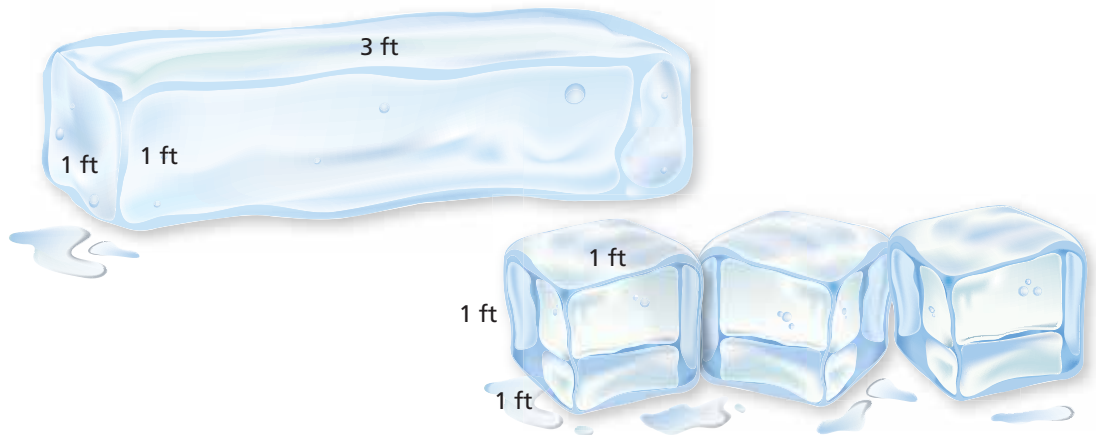
**Practice**

Use what you learned about the surface areas of rectangular prisms to complete Exercises 4–6 on page 359.

Key Vocabulary

lateral surface area,
p. 358

Key Idea

Surface Area of a Rectangular Prism

Words The surface area S of a rectangular prism is the sum of the areas of the bases and the lateral faces.

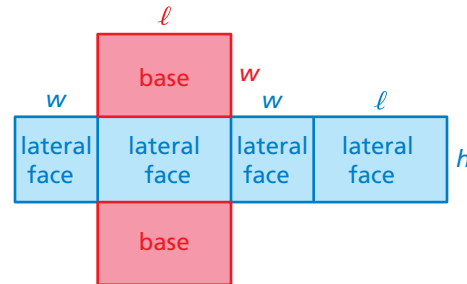
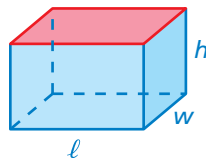

Algebra $S = 2lw + 2lh + 2wh$

Areas of
bases

Areas of
lateral faces

EXAMPLE 1 Finding the Surface Area of a Rectangular Prism

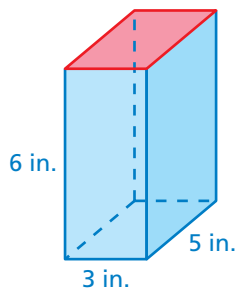

Find the surface area of the prism.

Draw a net.

$$\begin{aligned} S &= 2lw + 2lh + 2wh \\ &= 2(3)(5) + 2(3)(6) + 2(5)(6) \\ &= 30 + 36 + 60 \\ &= 126 \end{aligned}$$

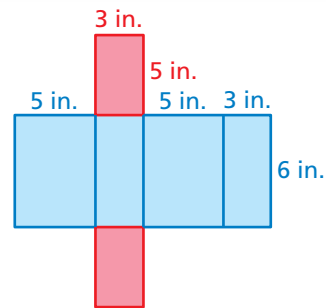

∴ The surface area is 126 square inches.

On Your Own

Find the surface area of the prism.

Now You're Ready
Exercises 7–9

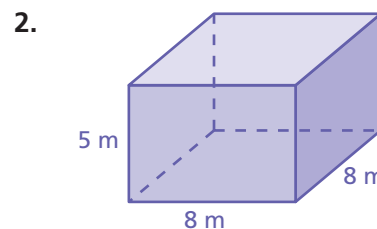
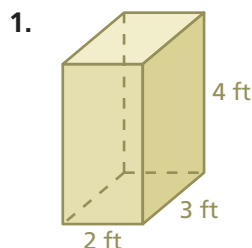

Key Idea

Surface Area of a Prism

The surface area S of any prism is the sum of the areas of the bases and the lateral faces.

$$S = \text{areas of bases} + \text{areas of lateral faces}$$

EXAMPLE 2 Finding the Surface Area of a Triangular Prism

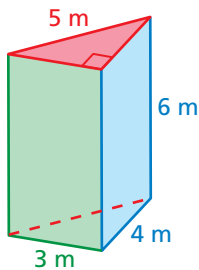

Find the surface area of the prism.

Draw a net.

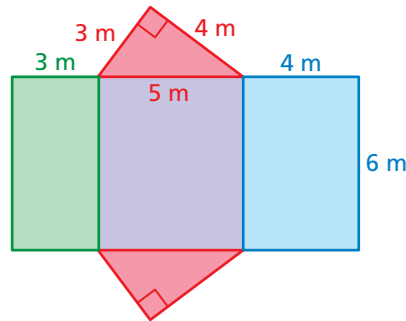

Remember

The area A of a triangle with base b and height h is $A = \frac{1}{2}bh$.

Area of a Base

$$\text{Red base: } \frac{1}{2} \cdot 3 \cdot 4 = 6$$

Areas of Lateral Faces

$$\text{Green lateral face: } 3 \cdot 6 = 18$$

$$\text{Purple lateral face: } 5 \cdot 6 = 30$$

$$\text{Blue lateral face: } 4 \cdot 6 = 24$$

Add the areas of the bases and the lateral faces.

$$S = \text{areas of bases} + \text{areas of lateral faces}$$

$$= 6 + 6 + 18 + 30 + 24$$

$$= 84$$

There are two identical bases. Count the area twice.

∴ The surface area is 84 square meters.

On Your Own

Find the surface area of the prism.

Now You're Ready
Exercises 10–12

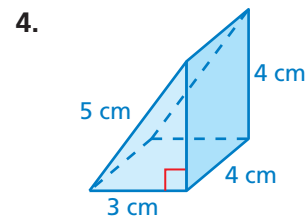
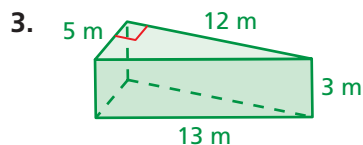

Remember



A cube has 6 congruent square faces.

When all the edges of a rectangular prism have the same length s , the rectangular prism is a cube. The formula for the surface area of a cube is

$$S = 6s^2. \quad \text{Formula for surface area of a cube}$$

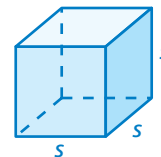

EXAMPLE 3 Finding the Surface Area of a Cube

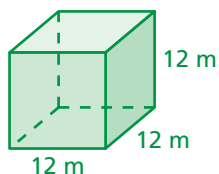

Find the surface area of the cube.

$$\begin{aligned} S &= 6s^2 && \text{Write formula for surface area of a cube.} \\ &= 6(12)^2 && \text{Substitute 12 for } s. \\ &= 864 && \text{Simplify.} \end{aligned}$$

❖ The surface area of the cube is 864 square meters.

The **lateral surface area** of a prism is the sum of the areas of the lateral faces.

EXAMPLE 4 Real-Life Application



The outsides of purple traps are coated with glue to catch emerald ash borers. You make your own trap in the shape of a rectangular prism with an open top and bottom. What is the surface area that you need to coat with glue?

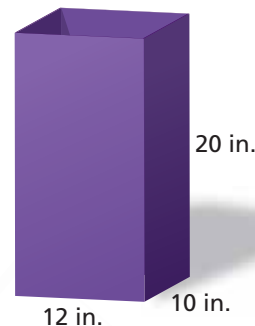

Find the lateral surface area.

$$\begin{aligned} S &= 2\ell h + 2wh && \leftarrow \text{Do not include the areas of the bases in the formula.} \\ &= 2(12)(20) + 2(10)(20) && \text{Substitute.} \\ &= 480 + 400 && \text{Multiply.} \\ &= 880 && \text{Add.} \end{aligned}$$



❖ So, you need to coat 880 square inches with glue.

On Your Own

Now You're Ready
Exercises 13–15

- Which prism has the greater surface area?
- WHAT IF?** In Example 4, both the length and the width of your trap are 12 inches. What is the surface area that you need to coat with glue?

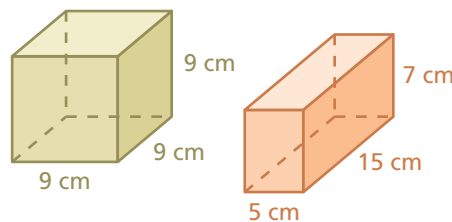

Vocabulary and Concept Check

- VOCABULARY** Describe two ways to find the surface area of a rectangular prism.
- WRITING** Compare and contrast a rectangular prism to a cube.
- DIFFERENT WORDS, SAME QUESTION** Which is different? Find “both” answers.

Find the surface area of the prism.

Find the area of the bases of the prism.

Find the area of the net of the prism.

Find the sum of the areas of the bases and the lateral faces of the prism.

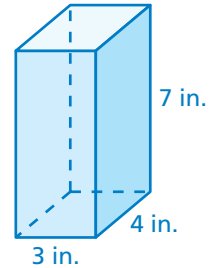

Practice and Problem Solving

Use one-inch cubes to form a rectangular prism that has the given dimensions. Then find the surface area of the prism.

4. $1 \times 2 \times 3$

5. $3 \times 4 \times 1$

6. $2 \times 3 \times 2$

Find the surface area of the prism.

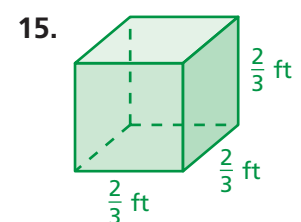
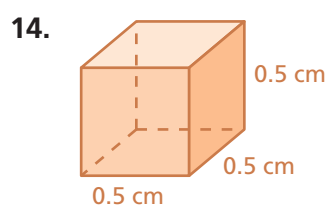
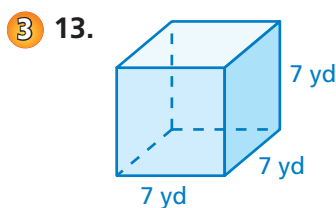
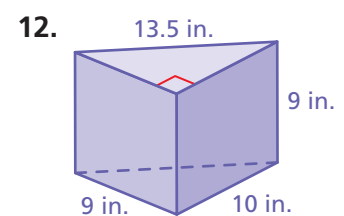
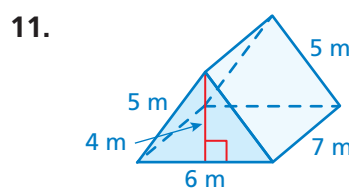
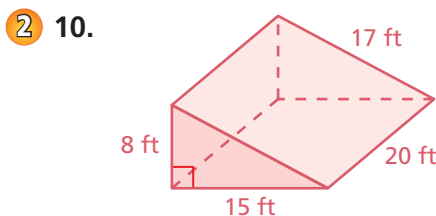
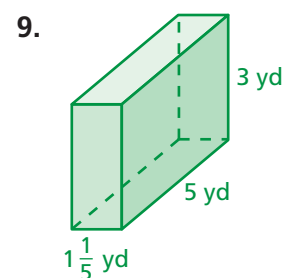
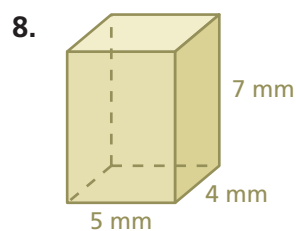
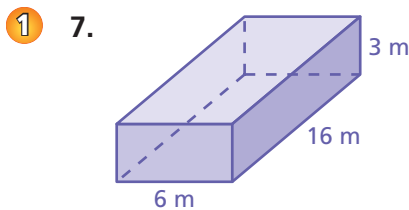

16. **ERROR ANALYSIS** Describe and correct the error in finding the surface area of the prism.

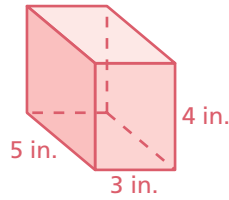

$$\begin{aligned}
 S &= 2(5)(3) + 2(3)(4) + 2(5)(3) \\
 &= 30 + 24 + 30 \\
 &= 84 \text{ in.}^2
 \end{aligned}$$

17. **GAME** Find the surface area of the tin game case.

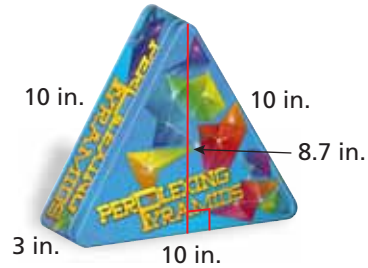

18. **WRAPPING PAPER** A cube-shaped gift is 11 centimeters long. What is the least amount of wrapping paper you need to wrap the gift?



19. **FROSTING** One can of frosting covers about 280 square inches. Is one can of frosting enough to frost the cake? Explain.

Find the surface area of the prism.

20.

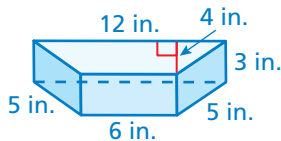

21.

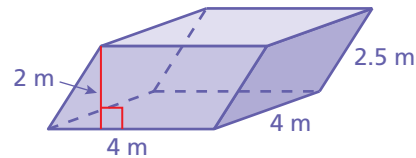

22. **OPEN-ENDED** Draw and label a rectangular prism that has a surface area of 158 square yards.

23. **LABEL** A label that wraps around a box of golf balls covers 75% of its lateral surface area. What is the value of x ?

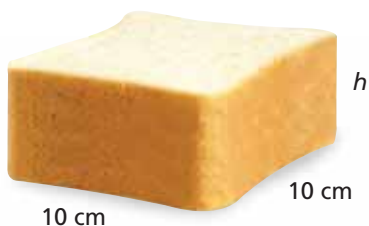

24. **BREAD** Fifty percent of the surface area of the bread is crust. What is the height h ?

Compare the dimensions of the prisms. How many times greater is the surface area of the red prism than the surface area of the blue prism?

25.

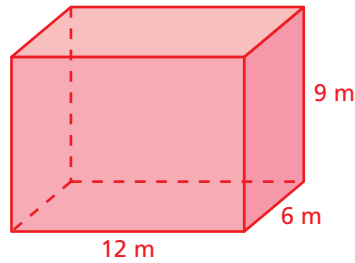
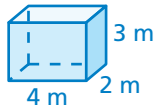

26.

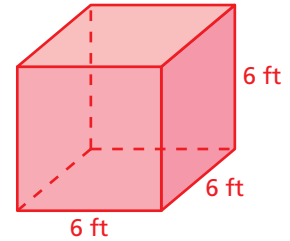
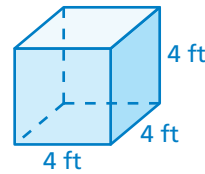

27. **STRUCTURE** You are painting the prize pedestals shown (including the bottoms). You need 0.5 pint of paint to paint the red pedestal.

- The side lengths of the green pedestal are one-half the side lengths of the red pedestal. How much paint do you need to paint the green pedestal?
- The side lengths of the blue pedestal are triple the side lengths of the green pedestal. How much paint do you need to paint the blue pedestal?
- Compare the ratio of paint amounts to the ratio of side lengths for the green and red pedestals. Repeat for the green and blue pedestals. What do you notice?

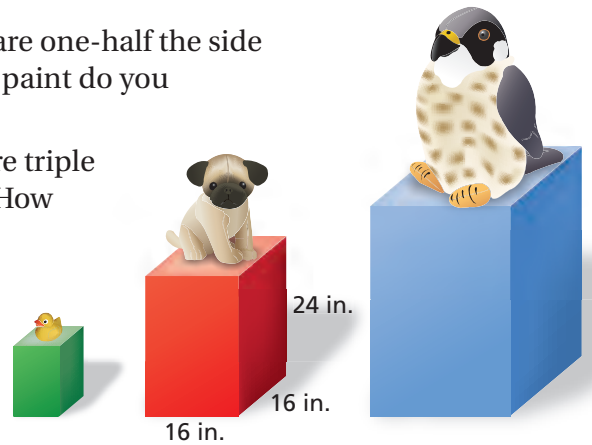

28. **Number Sense** A keychain-sized Rubik's Cube[®] is made up of small cubes. Each small cube has a surface area of 1.5 square inches.
- What is the side length of each small cube?
 - What is the surface area of the entire Rubik's Cube[®]?



Fair Game Review what you learned in previous grades & lessons

Find the area of the triangle *(Skills Review Handbook)*

29.

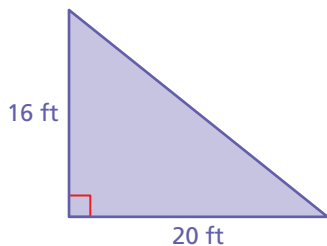

30.

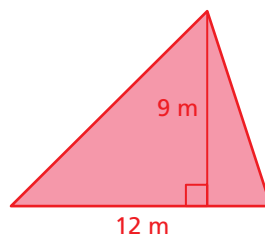

31.

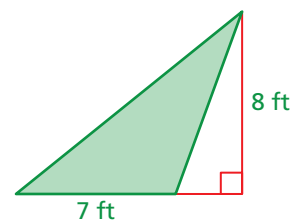

32. **MULTIPLE CHOICE** What is the circumference of the basketball?
Use 3.14 for π . *(Section 8.1)*

- (A) 14.13 in. (B) 28.26 in. (C) 56.52 in. (D) 254.34 in.



9.2 Surface Areas of Pyramids

Essential Question How can you find the surface area of a pyramid?

Even though many well-known pyramids have square bases, the base of a pyramid can be any polygon.

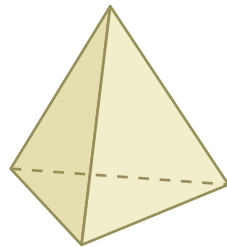

Triangular Base

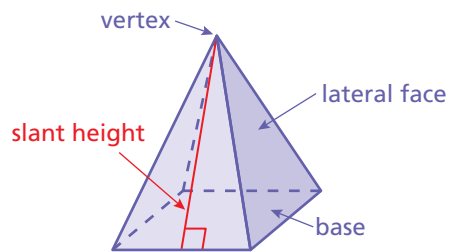

Square Base

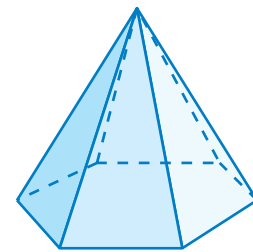

Hexagonal Base

1 ACTIVITY: Making a Scale Model

Work with a partner. Each pyramid has a square base.

- Draw a net for a scale model of one of the pyramids. Describe your scale.
- Cut out the net and fold it to form a pyramid.
- Find the lateral surface area of the real-life pyramid.

a. Cheops Pyramid in Egypt



Side = 230 m, Slant height \approx 186 m

b. Muttart Conservatory in Edmonton



Side = 26 m, Slant height \approx 27 m

c. Louvre Pyramid in Paris



Side = 35 m, Slant height \approx 28 m

d. Pyramid of Caius Cestius in Rome



Side = 22 m, Slant height \approx 29 m

Geometry

In this lesson, you will

- find surface areas of regular pyramids.
- solve real-life problems.

2 ACTIVITY: Estimation

Math Practice

Calculate Accurately

How can you verify that you have calculated the lateral surface area accurately?

Work with a partner. There are many different types of gemstone cuts. Here is one called a brilliant cut.

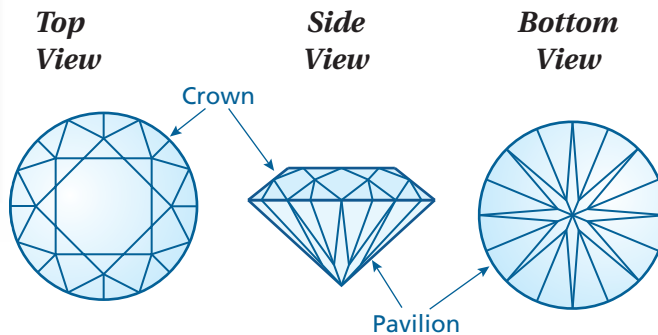

The size and shape of the pavilion can be approximated by an octagonal pyramid.

- What does *octagonal* mean?
- Draw a net for the pyramid.
- Find the lateral surface area of the pyramid.

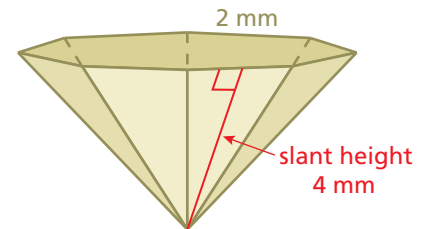

3 ACTIVITY: Comparing Surface Areas

Work with a partner. Both pyramids have the same side lengths of the base and the same slant heights.

- REASONING** Without calculating, which pyramid has the greater surface area? Explain.
- Verify your answer to part (a) by finding the surface area of each pyramid.

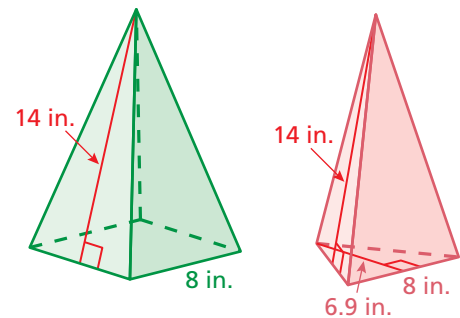

What Is Your Answer?

- IN YOUR OWN WORDS** How can you find the surface area of a pyramid? Draw a diagram with your explanation.

Practice

Use what you learned about the surface area of a pyramid to complete Exercises 4–6 on page 366.

Key Vocabulary

regular pyramid,
p. 364
slant height, p. 364

A **regular pyramid** is a pyramid whose base is a regular polygon. The lateral faces are triangles. The height of each triangle is the **slant height** of the pyramid.

Key Idea

Surface Area of a Pyramid

The surface area S of a pyramid is the sum of the areas of the base and the lateral faces.

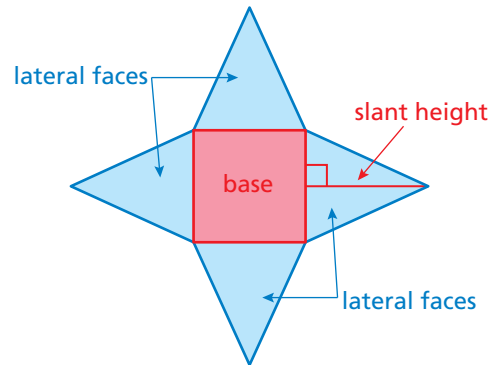
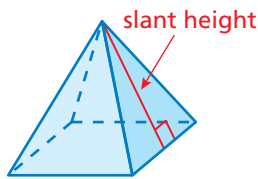

$$S = \text{area of base} + \text{areas of lateral faces}$$

Remember

In a regular polygon, all the sides are congruent and all the angles are congruent.

EXAMPLE 1 Finding the Surface Area of a Square Pyramid

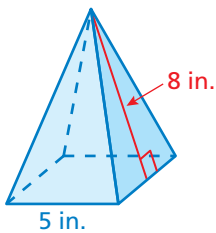

Find the surface area of the regular pyramid.

Draw a net.

Area of Base

$$5 \cdot 5 = 25$$

Area of a Lateral Face

$$\frac{1}{2} \cdot 5 \cdot 8 = 20$$

Find the sum of the areas of the base and the lateral faces.

$$S = \text{area of base} + \text{areas of lateral faces}$$

$$= 25 + 20 + 20 + 20 + 20$$

$$= 105$$

There are 4 identical lateral faces. Count the area 4 times.

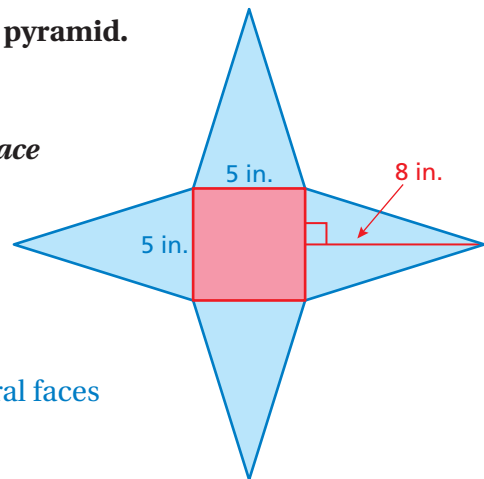

∴ The surface area is 105 square inches.

On Your Own

1. What is the surface area of a square pyramid with a base side length of 9 centimeters and a slant height of 7 centimeters?

EXAMPLE 2 Finding the Surface Area of a Triangular Pyramid

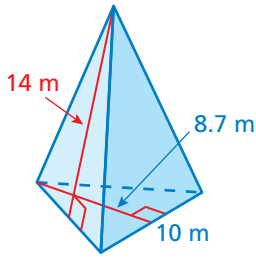

Find the surface area of the regular pyramid.

Draw a net.

Area of Base

$$\frac{1}{2} \cdot 10 \cdot 8.7 = 43.5$$

Area of a Lateral Face

$$\frac{1}{2} \cdot 10 \cdot 14 = 70$$

Find the sum of the areas of the base and the lateral faces.

$$\begin{aligned} S &= \text{area of base} + \text{areas of lateral faces} \\ &= 43.5 + 70 + 70 + 70 \\ &= 253.5 \end{aligned}$$

There are 3 identical lateral faces. Count the area 3 times.

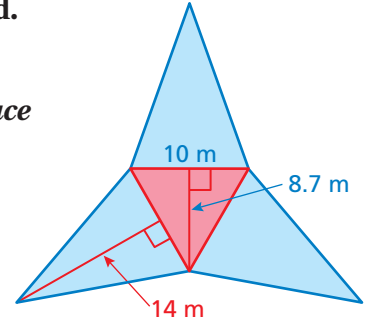

∴ The surface area is 253.5 square meters.

EXAMPLE 3 Real-Life Application

A roof is shaped like a square pyramid. One bundle of shingles covers 25 square feet. How many bundles should you buy to cover the roof?

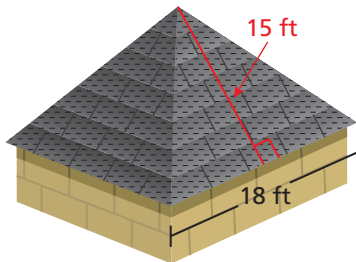

The base of the roof does not need shingles. So, find the sum of the areas of the lateral faces of the pyramid.

Area of a Lateral Face

$$\frac{1}{2} \cdot 18 \cdot 15 = 135$$

There are four identical lateral faces. So, the lateral surface area is

$$135 + 135 + 135 + 135 = 540.$$

Because one bundle of shingles covers 25 square feet, it will take $540 \div 25 = 21.6$ bundles to cover the roof.

∴ So, you should buy 22 bundles of shingles.

On Your Own

Now You're Ready
Exercises 7–12

- What is the surface area of the regular pyramid at the right?
- WHAT IF?** In Example 3, one bundle of shingles covers 32 square feet. How many bundles should you buy to cover the roof?

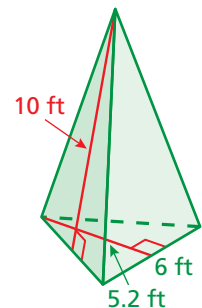

Vocabulary and Concept Check

- VOCABULARY** Can a pyramid have rectangles as lateral faces? Explain.
- CRITICAL THINKING** Why is it helpful to know the slant height of a pyramid to find its surface area?
- WHICH ONE DOESN'T BELONG?** Which description of the solid does *not* belong with the other three? Explain your answer.

square pyramid

regular pyramid

rectangular pyramid

triangular pyramid

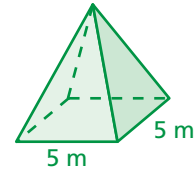

Practice and Problem Solving

Use the net to find the surface area of the regular pyramid.

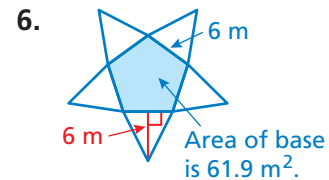
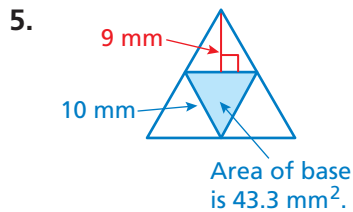
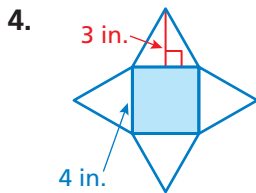

In Exercises 7–11, find the surface area of the regular pyramid.

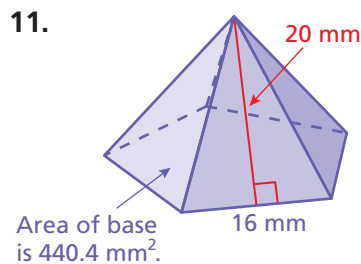
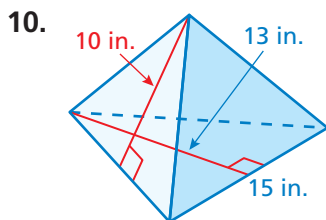
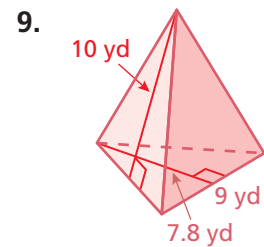
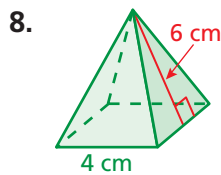
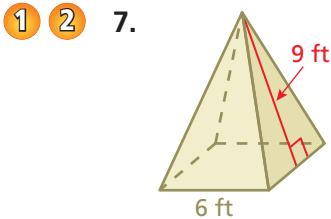

- LAMP SHADE** The base of the lampshade is a regular hexagon with a side length of 8 inches. Estimate the amount of glass needed to make the lampshade.
- GEOMETRY** The surface area of a square pyramid is 85 square meters. The base length is 5 meters. What is the slant height?

Find the surface area of the composite solid.

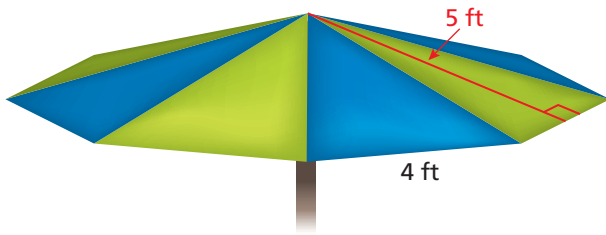
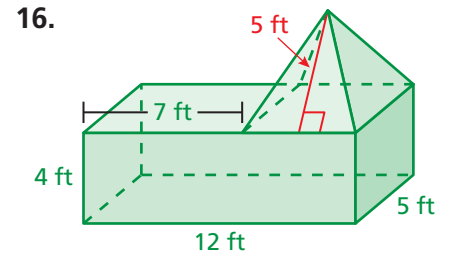
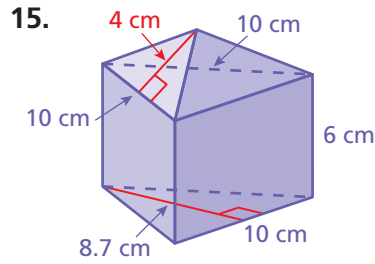
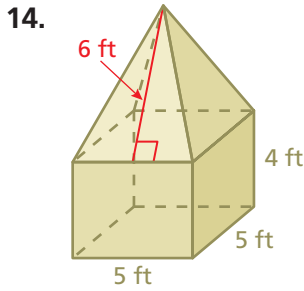

17. **PROBLEM SOLVING** You are making an umbrella that is shaped like a regular octagonal pyramid.
- Estimate the amount of fabric that you need to make the umbrella.
 - The fabric comes in rolls that are 60 inches wide. Draw a diagram of how you can cut the fabric from a roll that is 10 feet long.
 - How much fabric is wasted?

18. **REASONING** The *height* of a pyramid is the perpendicular distance between the base and the top of the pyramid. Which is greater, the height of a pyramid or the slant height? Explain your reasoning.

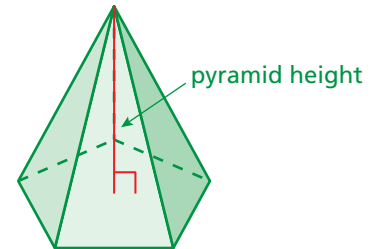

19. **TETRAHEDRON** A tetrahedron is a triangular pyramid whose four faces are identical equilateral triangles. The total lateral surface area is 93 square centimeters. Find the surface area of the tetrahedron.
20. **Reasoning** Is the total area of the lateral faces of a pyramid *greater than*, *less than*, or *equal to* the area of the base? Explain.



Fair Game Review what you learned in previous grades & lessons

Find the area and the circumference of the circle. Use 3.14 for π .
(Section 8.1 and Section 8.3)

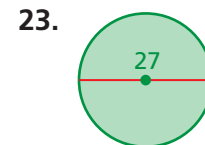
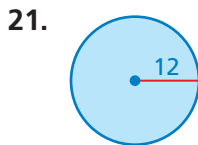

24. **MULTIPLE CHOICE** The distance between bases on a youth baseball field is proportional to the distance between bases on a professional baseball field. The ratio of the youth distance to the professional distance is 2 : 3. Bases on a youth baseball field are 60 feet apart. What is the distance between bases on a professional baseball field? (Section 5.4)

- (A) 40 ft (B) 90 ft (C) 120 ft (D) 180 ft

9.3 Surface Areas of Cylinders

Essential Question How can you find the surface area of a cylinder?

A *cylinder* is a solid that has two parallel, identical circular bases.

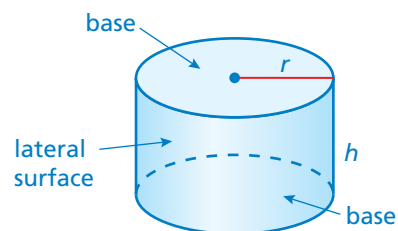

1 ACTIVITY: Finding Area

Work with a partner. Use a cardboard cylinder.

- Talk about how you can find the area of the outside of the roll.
- Estimate the area using the methods you discussed.
- Use the roll and the scissors to find the actual area of the cardboard.
- Compare the actual area to your estimates.



2 ACTIVITY: Finding Surface Area

Work with a partner.

Geometry

In this lesson, you will

- find surface areas of cylinders.



- Make a net for the can. Name the shapes in the net.
- Find the surface area of the can.
- How are the dimensions of the rectangle related to the dimensions of the can?

3 ACTIVITY: Estimation

Math Practice

View as Components

How can you use the results of Activity 2 to help you identify the components of the surface area?

Work with a partner. From memory, estimate the dimensions of the real-life item in inches. Then use the dimensions to estimate the surface area of the item in square inches.

a.



b.



c.



d.



What Is Your Answer?

- IN YOUR OWN WORDS** How can you find the surface area of a cylinder? Give an example with your description. Include a drawing of the cylinder.
- To eight decimal places, $\pi \approx 3.14159265$. Which of the following is closest to π ?
 - 3.14
 - $\frac{22}{7}$
 - $\frac{355}{113}$

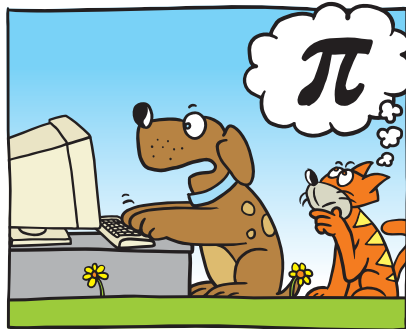

"To approximate $\pi \approx 3.141593$, I simply remember 1, 1, 3, 3, 5, 5."



"Then I compute $\frac{355}{113} \approx 3.141593$."

Practice

Use what you learned about the surface area of a cylinder to complete Exercises 3–5 on page 372.

Key Idea

Surface Area of a Cylinder

Words The surface area S of a cylinder is the sum of the areas of the bases and the lateral surface.

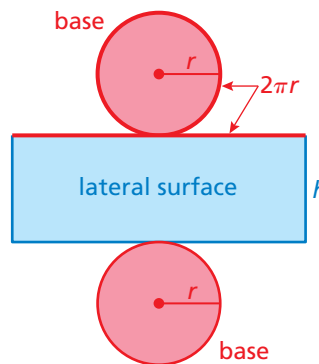
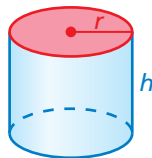

Algebra $S = 2\pi r^2 + 2\pi rh$

Areas of bases

Area of lateral surface

Remember



Pi can be approximated as 3.14 or $\frac{22}{7}$.

EXAMPLE 1 Finding the Surface Area of a Cylinder

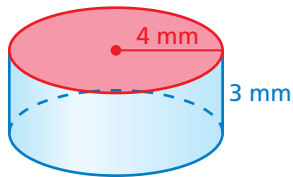

Find the surface area of the cylinder. Round your answer to the nearest tenth.

Draw a net.

$$\begin{aligned} S &= 2\pi r^2 + 2\pi rh \\ &= 2\pi(4)^2 + 2\pi(4)(3) \\ &= 32\pi + 24\pi \\ &= 56\pi \\ &\approx 175.8 \end{aligned}$$

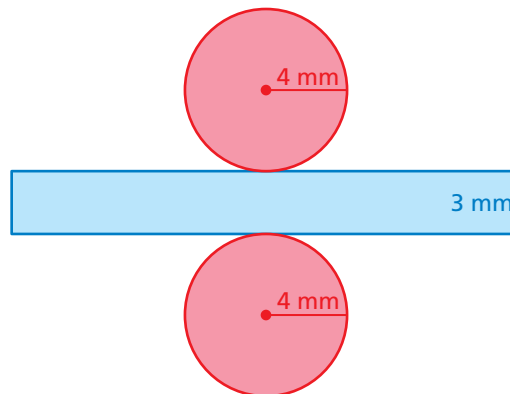

∴ The surface area is about 175.8 square millimeters.

On Your Own

Find the surface area of the cylinder. Round your answer to the nearest tenth.

Now You're Ready
Exercises 6–8

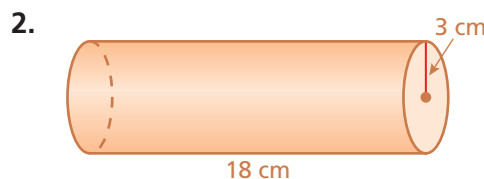
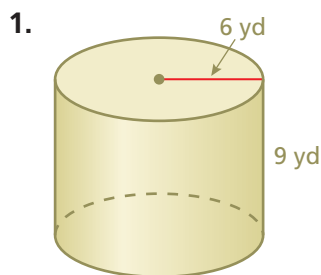

EXAMPLE 2 Finding Surface Area

How much paper is used for the label on the can of peas?

Find the lateral surface area of the cylinder.



$$\begin{aligned}
 S &= 2\pi rh && \leftarrow \text{Do not include the areas of the bases in the formula.} \\
 &= 2\pi(1)(2) && \text{Substitute.} \\
 &= 4\pi \approx 12.56 && \text{Multiply.}
 \end{aligned}$$

⋮ About 12.56 square inches of paper is used for the label.

EXAMPLE 3 Real-Life Application

You earn \$0.01 for recycling the can in Example 2. How much can you expect to earn for recycling the tomato can? Assume that the recycle value is proportional to the surface area.

Find the surface area of each can.



Tomatoes

$$\begin{aligned}
 S &= 2\pi r^2 + 2\pi rh \\
 &= 2\pi(2)^2 + 2\pi(2)(5.5) \\
 &= 8\pi + 22\pi \\
 &= 30\pi
 \end{aligned}$$

Peas

$$\begin{aligned}
 S &= 2\pi r^2 + 2\pi rh \\
 &= 2\pi(1)^2 + 2\pi(1)(2) \\
 &= 2\pi + 4\pi \\
 &= 6\pi
 \end{aligned}$$

Use a proportion to find the recycle value x of the tomato can.

$$\frac{30\pi \text{ in.}^2}{x} = \frac{6\pi \text{ in.}^2}{\$0.01}$$

← surface area
← recycle value

$$30\pi \cdot 0.01 = x \cdot 6\pi \quad \text{Cross Products Property}$$

$$5 \cdot 0.01 = x \quad \text{Divide each side by } 6\pi.$$

$$0.05 = x \quad \text{Simplify.}$$

⋮ You can expect to earn \$0.05 for recycling the tomato can.

On Your Own

Now You're Ready
Exercises 9–11

3. **WHAT IF?** In Examples 2 and 3, the height of the can of peas is doubled.

- Does the amount of paper used in the label double?
- Does the recycle value double? Explain.

Vocabulary and Concept Check

- CRITICAL THINKING** Which part of the formula $S = 2\pi r^2 + 2\pi rh$ represents the lateral surface area of a cylinder?
- CRITICAL THINKING** You are given the height and the circumference of the base of a cylinder. Describe how to find the surface area of the entire cylinder.

Practice and Problem Solving

Make a net for the cylinder. Then find the surface area of the cylinder. Round your answer to the nearest tenth.

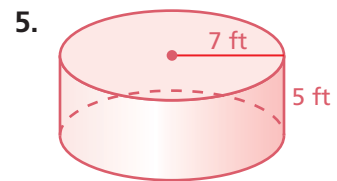
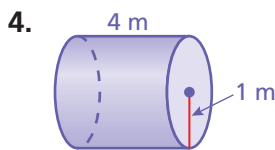
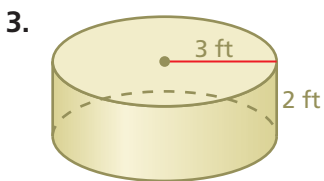

Find the surface area of the cylinder. Round your answer to the nearest tenth.

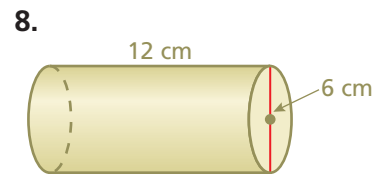
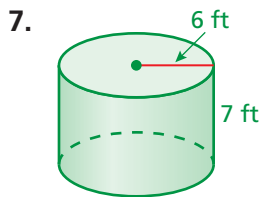
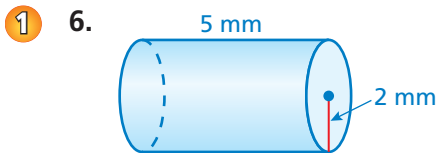

Find the lateral surface area of the cylinder. Round your answer to the nearest tenth.

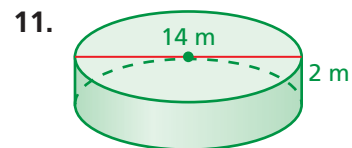
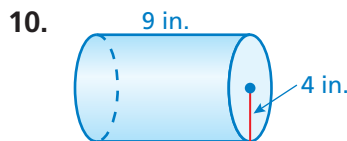
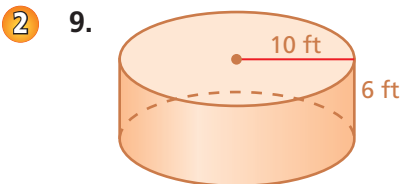

12. **ERROR ANALYSIS** Describe and correct the error in finding the surface area of the cylinder.

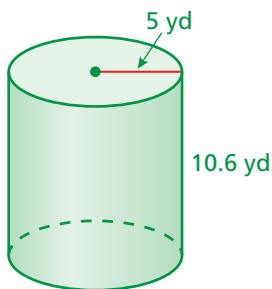

X

$$\begin{aligned} S &= \pi r^2 + 2\pi rh \\ &= \pi(5)^2 + 2\pi(5)(10.6) \\ &= 25\pi + 106\pi \\ &= 131\pi \approx 411.3 \text{ yd}^2 \end{aligned}$$

13. **TANKER** The truck's tank is a stainless steel cylinder. Find the surface area of the tank.

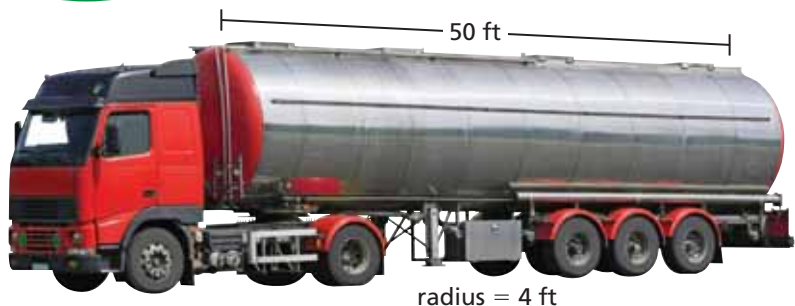

14. **OTTOMAN** What percent of the surface area of the ottoman is green (not including the bottom)?

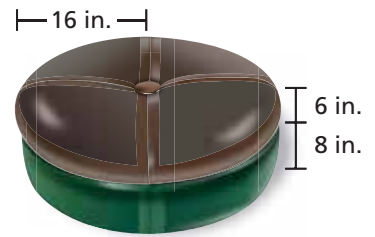

15. **REASONING** You make two cylinders using 8.5-by-11-inch pieces of paper. One has a height of 8.5 inches, and the other has a height of 11 inches. Without calculating, compare the surface areas of the cylinders.



16. **INSTRUMENT** A *ganza* is a percussion instrument used in samba music.
- Find the surface area of each of the two labeled ganzas.
 - The weight of the smaller *ganza* is 1.1 pounds. Assume that the surface area is proportional to the weight. What is the weight of the larger *ganza*?

17. **BRIE CHEESE** The cut wedge represents one-eighth of the cheese.

- Find the surface area of the cheese before it is cut.
- Find the surface area of the remaining cheese after the wedge is removed. Did the surface area increase, decrease, or remain the same?

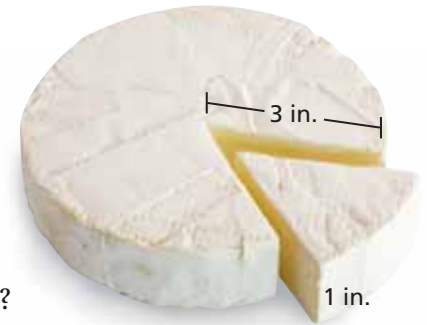

18. **Repeated Reasoning** A cylinder has radius r and height h .
- How many times greater is the surface area of a cylinder when both dimensions are multiplied by a factor of 2? 3? 5? 10?
 - Describe the pattern in part (a). How many times greater is the surface area of a cylinder when both dimensions are multiplied by a factor of 20?

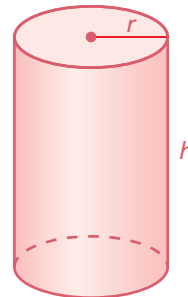

Fair Game Review what you learned in previous grades & lessons

Find the area. *(Skills Review Handbook)*

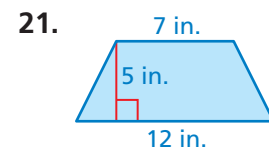
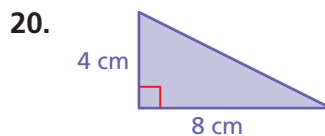
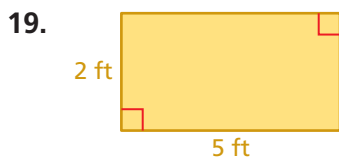

22. **MULTIPLE CHOICE** 40% of what number is 80? *(Section 6.4)*

- (A) 32 (B) 48 (C) 200 (D) 320

You can use an **information frame** to help you organize and remember concepts. Here is an example of an information frame for surface areas of rectangular prisms.

Surface Areas of Rectangular Prisms

Visual:

Algebra:

$$S = 2lw + 2lh + 2wh$$

↑ ↑ ↑
Areas of bases Areas of lateral faces

Words:

The surface area S of a rectangular prism is the sum of the areas of the bases and the lateral faces.

Example:

$$\begin{aligned}
 S &= 2lw + 2lh + 2wh \\
 &= 2(3)(4) + 2(3)(5) + 2(4)(5) \\
 &= 24 + 30 + 40 \\
 &= 94 \text{ in.}^2
 \end{aligned}$$

On Your Own

Make information frames to help you study the topics.

1. surface areas of prisms
2. surface areas of pyramids
3. surface areas of cylinders

After you complete this chapter, make information frames for the following topics.

4. volumes of prisms
5. volumes of pyramids

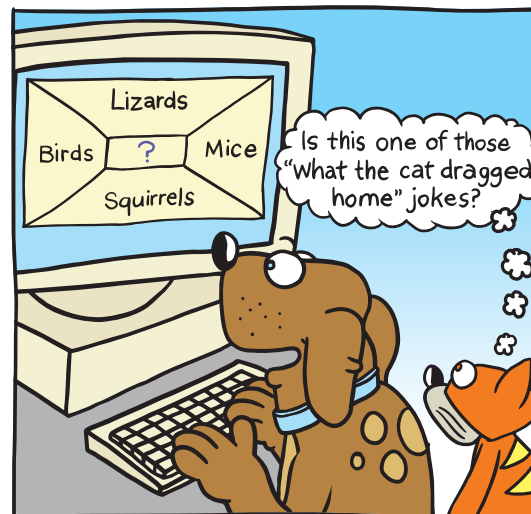

"I'm having trouble thinking of a good title for my **information frame**."

Find the surface area of the prism. (Section 9.1)

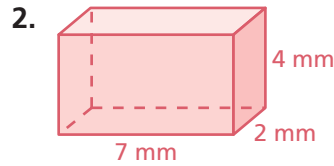
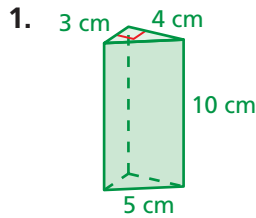

Find the surface area of the regular pyramid. (Section 9.2)

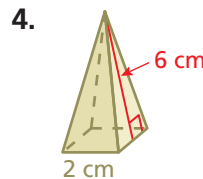
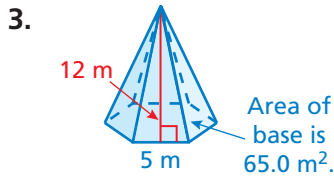

Find the surface area of the cylinder. Round your answer to the nearest tenth. (Section 9.3)

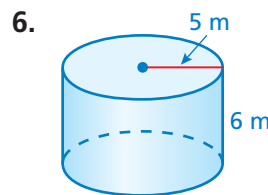
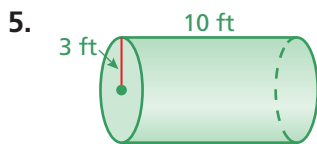

Find the lateral surface area of the cylinder. Round your answer to the nearest tenth. (Section 9.3)

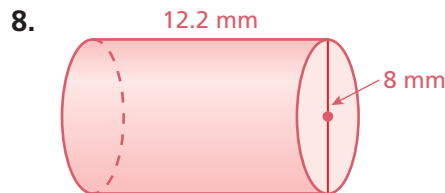
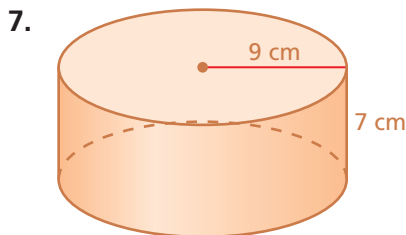

9. **SKYLIGHT** You are making a skylight that has 12 triangular pieces of glass and a slant height of 3 feet. Each triangular piece has a base of 1 foot. (Section 9.2)

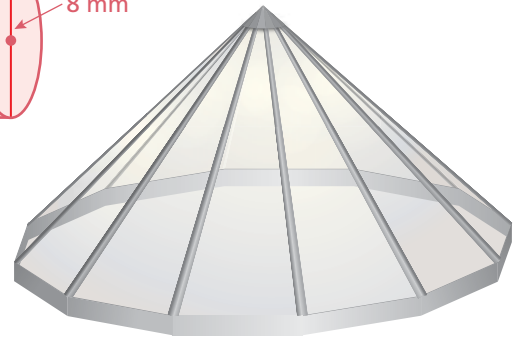

- How much glass will you need to make the skylight?
- Can you cut the 12 glass triangles from a sheet of glass that is 4 feet by 8 feet? If so, draw a diagram showing how this can be done.

10. **MAILING TUBE** What is the least amount of material needed to make the mailing tube? (Section 9.3)

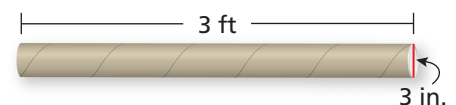

11. **WOODEN CHEST** All the faces of the wooden chest will be painted except for the bottom. Find the area to be painted, in square inches. (Section 9.1)



9.4 Volumes of Prisms

Essential Question How can you find the volume of a prism?

1 ACTIVITY: Pearls in a Treasure Chest

Work with a partner. A treasure chest is filled with valuable pearls. Each pearl is about 1 centimeter in diameter and is worth about \$80.

Use the diagrams below to describe two ways that you can estimate the number of pearls in the treasure chest.

a.

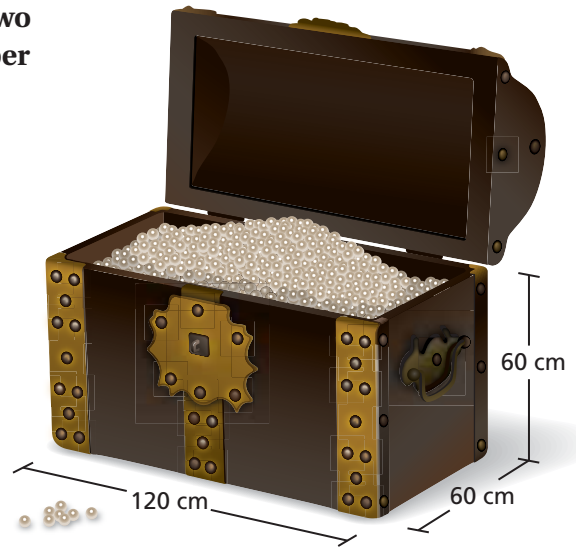
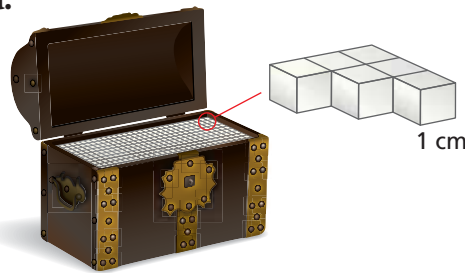

b.



c. Use the method in part (a) to estimate the value of the pearls in the chest.

2 ACTIVITY: Finding a Formula for Volume

Geometry

In this lesson, you will

- find volumes of prisms.
- solve real-life problems.

Work with a partner. You know that the formula for the volume of a rectangular prism is $V = \ell wh$.

- Write a formula that gives the volume in terms of the area of the base B and the height h .
- Use both formulas to find the volume of each prism. Do both formulas give you the same volume?

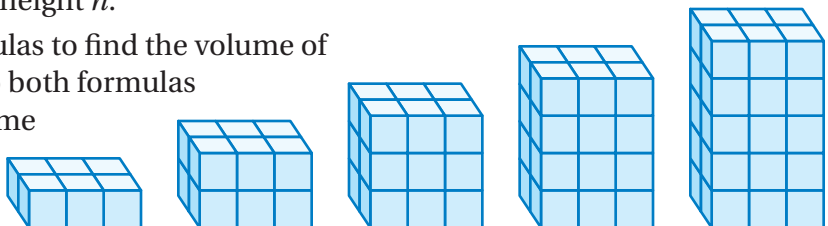

3 ACTIVITY: Finding a Formula for Volume

Math Practice

Use a Formula

What are the given quantities? How can you use the quantities to write a formula?

Work with a partner. Use the concept in Activity 2 to find a formula that gives the volume of any prism.

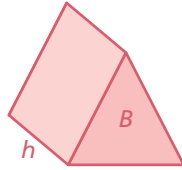

Triangular Prism

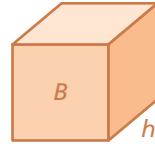

Rectangular Prism

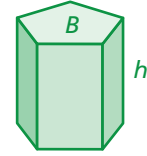

Pentagonal Prism

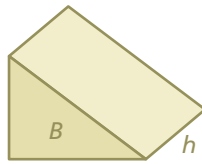

Triangular Prism

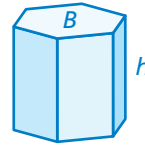

Hexagonal Prism

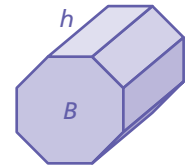

Octagonal Prism

4 ACTIVITY: Using a Formula



STEM
VIDEO

Work with a partner. A ream of paper has 500 sheets.

- Does a single sheet of paper have a volume? Why or why not?
- If so, explain how you can find the volume of a single sheet of paper.



What Is Your Answer?

- IN YOUR OWN WORDS** How can you find the volume of a prism?
- STRUCTURE** Draw a prism that has a trapezoid as its base. Use your formula to find the volume of the prism.

Practice

Use what you learned about the volumes of prisms to complete Exercises 4–6 on page 380.

The *volume* of a three-dimensional figure is a measure of the amount of space that it occupies. Volume is measured in cubic units.

Key Idea

Volume of a Prism

Words The volume V of a prism is the product of the area of the base and the height of the prism.

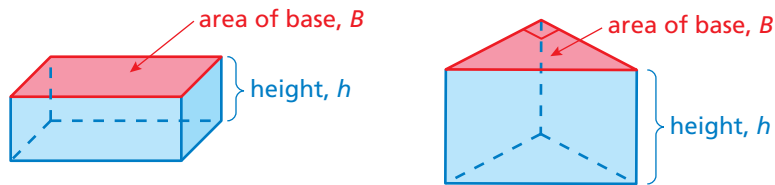

Algebra

$$V = Bh$$

Area of base

Height of prism

Remember



The volume V of a cube with an edge length of s is $V = s^3$.

EXAMPLE 1 Finding the Volume of a Prism

Study Tip



The area of the base of a rectangular prism is the product of the length ℓ and the width w .

You can use $V = \ell wh$ to find the volume of a rectangular prism.

Find the volume of the prism.

$$\begin{aligned} V &= Bh && \text{Write formula for volume.} \\ &= 6(8) \cdot 15 && \text{Substitute.} \\ &= 48 \cdot 15 && \text{Simplify.} \\ &= 720 && \text{Multiply.} \end{aligned}$$

∴ The volume is 720 cubic yards.

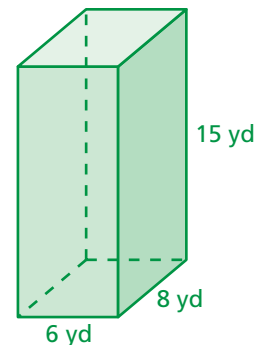

EXAMPLE 2 Finding the Volume of a Prism

Find the volume of the prism.

$$\begin{aligned} V &= Bh && \text{Write formula for volume.} \\ &= \frac{1}{2}(5.5)(2) \cdot 4 && \text{Substitute.} \\ &= 5.5 \cdot 4 && \text{Simplify.} \\ &= 22 && \text{Multiply.} \end{aligned}$$

∴ The volume is 22 cubic inches.

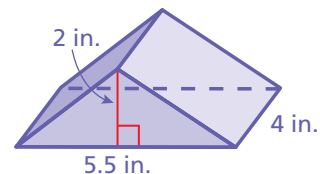

On Your Own

Find the volume of the prism.

1.

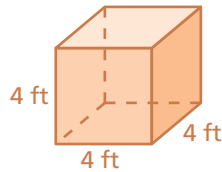

2.

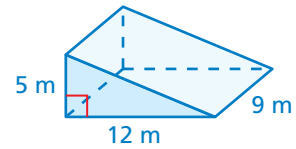

EXAMPLE 3 Real-Life Application

A movie theater designs two bags to hold 96 cubic inches of popcorn.

(a) Find the height of each bag. (b) Which bag should the theater choose to reduce the amount of paper needed? Explain.

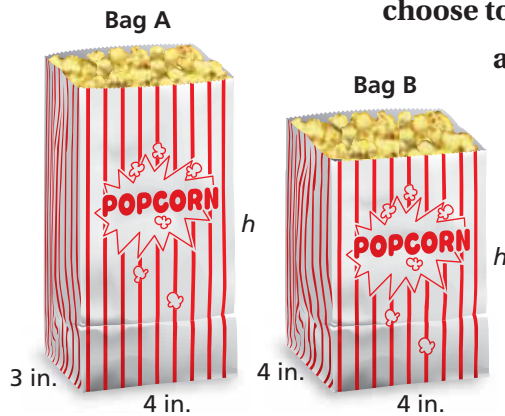

a. Find the height of each bag.

Bag A

$$V = Bh$$

$$96 = 4(3)(h)$$

$$96 = 12h$$

$$8 = h$$

∴ The height is 8 inches.

Bag B

$$V = Bh$$

$$96 = 4(4)(h)$$

$$96 = 16h$$

$$6 = h$$

∴ The height is 6 inches.

b. To determine the amount of paper needed, find the surface area of each bag. Do not include the top base.

Bag A

$$S = \ell w + 2\ell h + 2wh$$

$$= 4(3) + 2(4)(8) + 2(3)(8)$$

$$= 12 + 64 + 48$$

$$= 124 \text{ in.}^2$$

Bag B

$$S = \ell w + 2\ell h + 2wh$$

$$= 4(4) + 2(4)(6) + 2(4)(6)$$

$$= 16 + 48 + 48$$

$$= 112 \text{ in.}^2$$

∴ The surface area of Bag B is less than the surface area of Bag A. So, the theater should choose Bag B.

On Your Own

3. You design Bag C that has a volume of 96 cubic inches. Should the theater in Example 3 choose your bag? Explain.

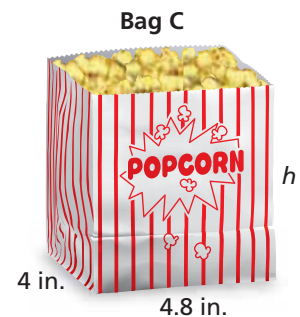

Vocabulary and Concept Check

- VOCABULARY** What types of units are used to describe volume?
- VOCABULARY** Explain how to find the volume of a prism.
- CRITICAL THINKING** How are volume and surface area different?

Practice and Problem Solving

Find the volume of the prism.

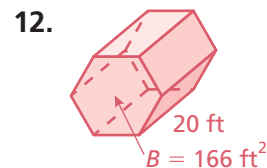
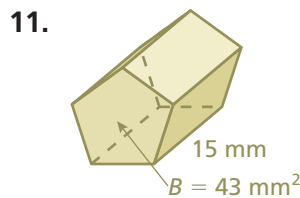
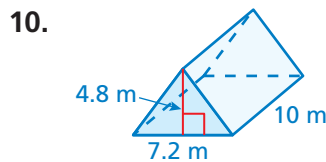
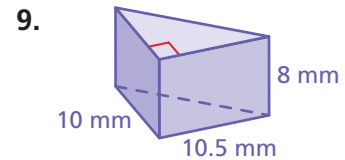
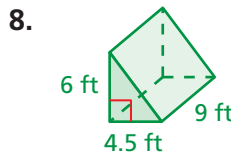
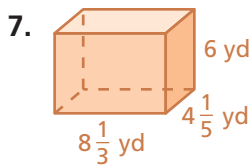
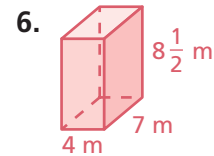
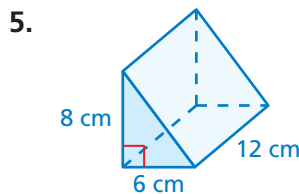
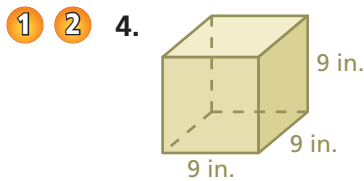

13. **ERROR ANALYSIS** Describe and correct the error in finding the volume of the triangular prism.

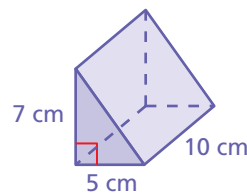

X $V = Bh$
 $= 10(5)(7)$
 $= 50 \cdot 7$
 $= 350 \text{ cm}^3$

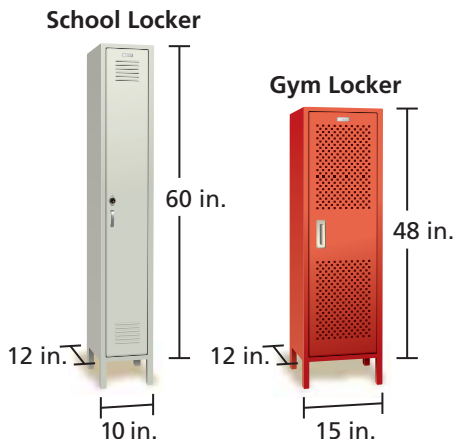

14. **LOCKER** Each locker is shaped like a rectangular prism. Which has more storage space? Explain.
15. **CEREAL BOX** A cereal box is 9 inches by 2.5 inches by 10 inches. What is the volume of the box?

Find the volume of the prism.

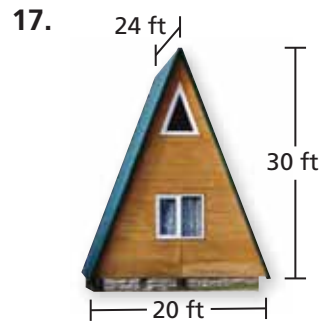

18. **LOGIC** Two prisms have the same volume. Do they *always*, *sometimes*, or *never* have the same surface area? Explain.

19. **CUBIC UNITS** How many cubic inches are in a cubic foot? Use a sketch to explain your reasoning.

20. **CAPACITY** As a gift, you fill the calendar with packets of chocolate candy. Each packet has a volume of 2 cubic inches. Find the maximum number of packets you can fit inside the calendar.



21. **PRECISION** Two liters of water are poured into an empty vase shaped like an octagonal prism. The base area is 100 square centimeters. What is the height of the water? (1 L = 1000 cm³)

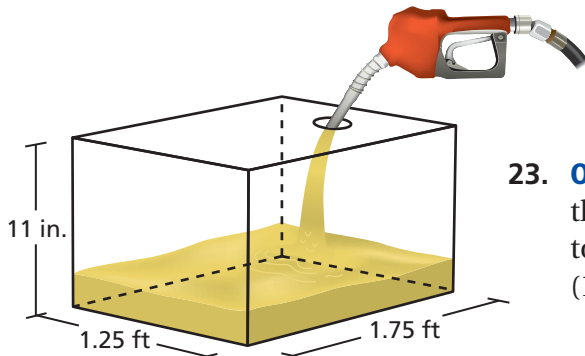

22. **GAS TANK** The gas tank is 20% full. Use the current price of regular gasoline in your community to find the cost to fill the tank. (1 gal = 231 in.³)

23. **OPEN-ENDED** You visit an aquarium. One of the tanks at the aquarium holds 450 gallons of water. Draw a diagram to show one possible set of dimensions of the tank. (1 gal = 231 in.³)

24. **Critical Thinking** How many times greater is the volume of a triangular prism when one of its dimensions is doubled? when all three dimensions are doubled?

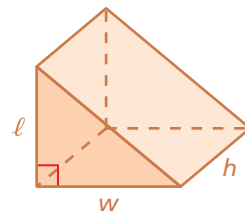

Fair Game Review What you learned in previous grades & lessons

Find the selling price. (Section 6.6)

25. Cost to store: \$75
Markup: 20%

26. Cost to store: \$90
Markup: 60%

27. Cost to store: \$130
Markup: 85%

28. **MULTIPLE CHOICE** What is the approximate surface area of a cylinder with a radius of 3 inches and a height of 10 inches? (Section 9.3)

(A) 30 in.²

(B) 87 in.²

(C) 217 in.²

(D) 245 in.²

9.5 Volumes of Pyramids

Essential Question

How can you find the volume of a pyramid?

1 ACTIVITY: Finding a Formula Experimentally

Work with a partner.

- Draw the two nets on cardboard and cut them out.

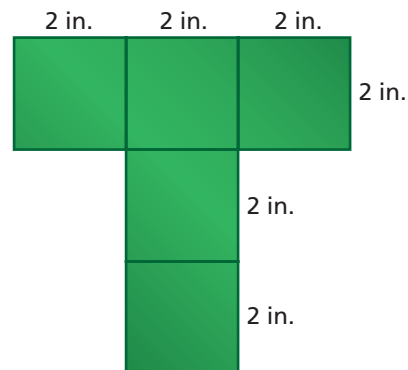
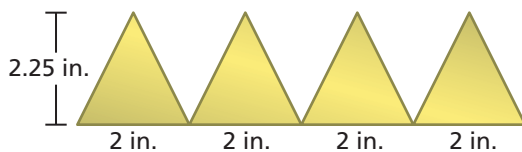

- Fold and tape the nets to form an open square box and an open pyramid.
- Both figures should have the same size square base and the same height.
- Fill the pyramid with pebbles. Then pour the pebbles into the box. Repeat this until the box is full. How many pyramids does it take to fill the box?
- Use your result to find a formula for the volume of a pyramid.

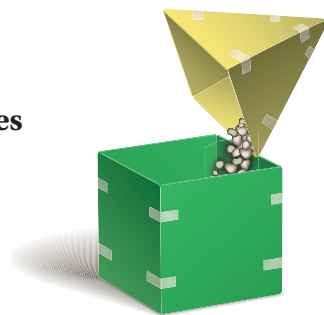

2 ACTIVITY: Comparing Volumes

Work with a partner. You are an archaeologist studying two ancient pyramids. What factors would affect how long it took to build each pyramid? Given similar conditions, which pyramid took longer to build? Explain your reasoning.

Geometry

In this lesson, you will

- find volumes of pyramids.
- solve real-life problems.



The Sun Pyramid in Mexico
Height: about 246 ft
Base: about 738 ft by 738 ft



Cheops Pyramid in Egypt
Height: about 480 ft
Base: about 755 ft by 755 ft

3 ACTIVITY: Finding and Using a Pattern

Math Practice

Look for Patterns

As the height and the base lengths increase, how does this pattern affect the volume? Explain.

Work with a partner.

- Find the volumes of the pyramids.
- Organize your results in a table.
- Describe the pattern.
- Use your pattern to find the volume of a pyramid with a base length and a height of 20.

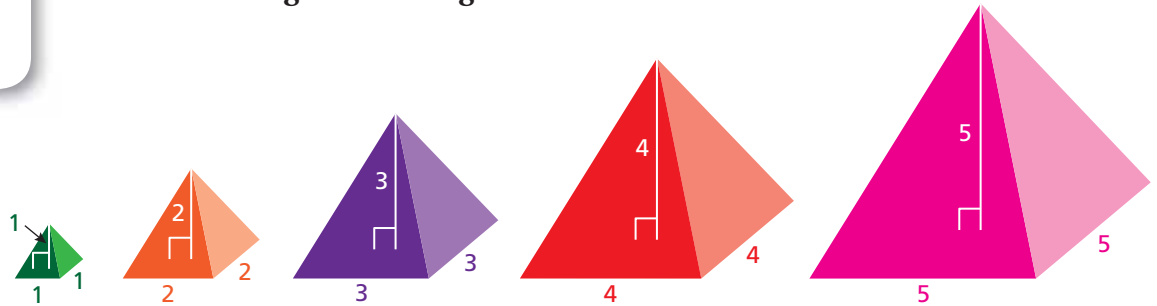

4 ACTIVITY: Breaking a Prism into Pyramids

Work with a partner. The rectangular prism can be cut to form three pyramids. Show that the sum of the volumes of the three pyramids is equal to the volume of the prism.

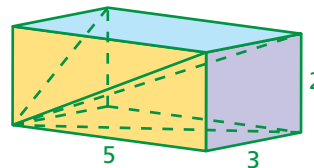

a.

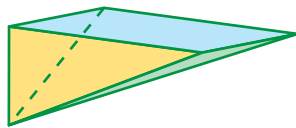

b.

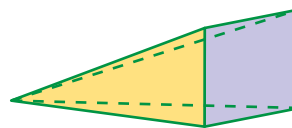

c.

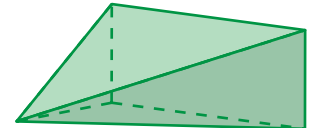

What Is Your Answer?

5. **IN YOUR OWN WORDS** How can you find the volume of a pyramid?
6. **STRUCTURE** Write a general formula for the volume of a pyramid.

Practice

Use what you learned about the volumes of pyramids to complete Exercises 4–6 on page 386.

Key Idea

Volume of a Pyramid

Words The volume V of a pyramid is one-third the product of the area of the base and the height of the pyramid.

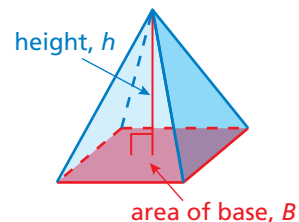

Algebra $V = \frac{1}{3}Bh$

Area of base (points to B)

Height of pyramid (points to h)

Study Tip

The *height* of a pyramid is the perpendicular distance from the base to the vertex.

EXAMPLE 1 Finding the Volume of a Pyramid

Find the volume of the pyramid.

$$\begin{aligned} V &= \frac{1}{3}Bh && \text{Write formula for volume.} \\ &= \frac{1}{3}(48)(9) && \text{Substitute.} \\ &= 144 && \text{Multiply.} \end{aligned}$$

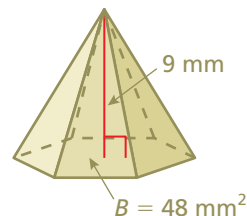

∴ The volume is 144 cubic millimeters.

EXAMPLE 2 Finding the Volume of a Pyramid

Find the volume of the pyramid.

Study Tip

The area of the base of a rectangular pyramid is the product of the length ℓ and the width w .

You can use $V = \frac{1}{3}\ell wh$ to find the volume of a rectangular pyramid.

a.

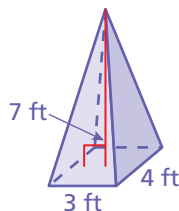

$$\begin{aligned} V &= \frac{1}{3}Bh \\ &= \frac{1}{3}(4)(3)(7) \\ &= 28 \end{aligned}$$

∴ The volume is 28 cubic feet.

b.

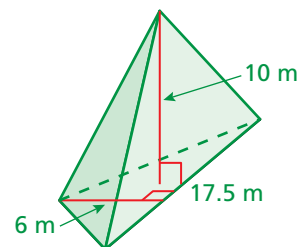

$$\begin{aligned} V &= \frac{1}{3}Bh \\ &= \frac{1}{3}\left(\frac{1}{2}\right)(17.5)(6)(10) \\ &= 175 \end{aligned}$$

∴ The volume is 175 cubic meters.

On Your Own

Now You're Ready
Exercises 4–11

Find the volume of the pyramid.

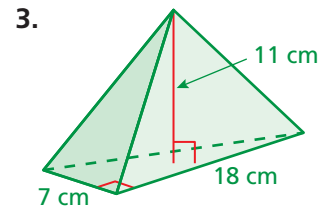
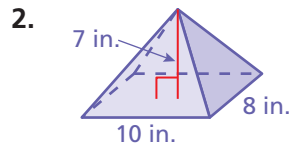
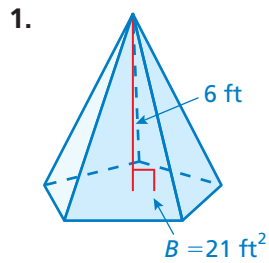

EXAMPLE 3 Real-Life Application

a. The volume of sunscreen in Bottle B is about how many times the volume in Bottle A?

b. Which is the better buy?

a. Use the formula for the volume of a pyramid to estimate the amount of sunscreen in each bottle.

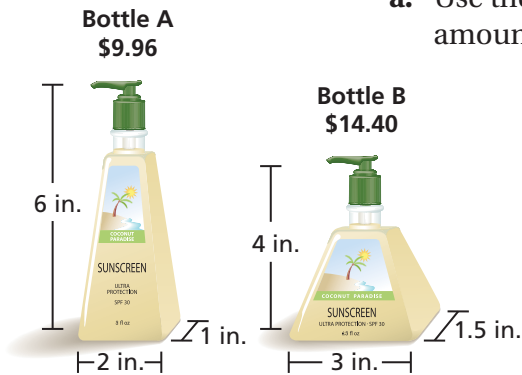

Bottle A

$$\begin{aligned} V &= \frac{1}{3}Bh \\ &= \frac{1}{3}(2)(1)(6) \\ &= 4 \text{ in.}^3 \end{aligned}$$

Bottle B

$$\begin{aligned} V &= \frac{1}{3}Bh \\ &= \frac{1}{3}(3)(1.5)(4) \\ &= 6 \text{ in.}^3 \end{aligned}$$

∴ So, the volume of sunscreen in Bottle B is about $\frac{6}{4} = 1.5$ times the volume in Bottle A.

b. Find the unit cost for each bottle.

Bottle A

$$\begin{aligned} \frac{\text{cost}}{\text{volume}} &= \frac{\$9.96}{4 \text{ in.}^3} \\ &= \frac{\$2.49}{1 \text{ in.}^3} \end{aligned}$$

Bottle B

$$\begin{aligned} \frac{\text{cost}}{\text{volume}} &= \frac{\$14.40}{6 \text{ in.}^3} \\ &= \frac{\$2.40}{1 \text{ in.}^3} \end{aligned}$$

∴ The unit cost of Bottle B is less than the unit cost of Bottle A. So, Bottle B is the better buy.

On Your Own

Now You're Ready
Exercise 16

4. Bottle C is on sale for \$13.20. Is Bottle C a better buy than Bottle B in Example 3? Explain.

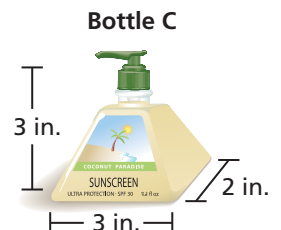

Vocabulary and Concept Check

- WRITING** How is the formula for the volume of a pyramid different from the formula for the volume of a prism?
- OPEN-ENDED** Describe a real-life situation that involves finding the volume of a pyramid.
- REASONING** A triangular pyramid and a triangular prism have the same base and height. The volume of the prism is how many times the volume of the pyramid?

Practice and Problem Solving

Find the volume of the pyramid.

1 2

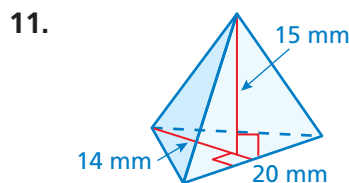
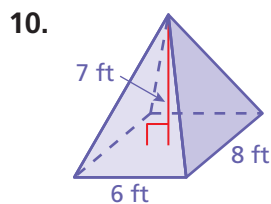
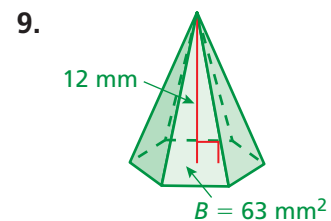
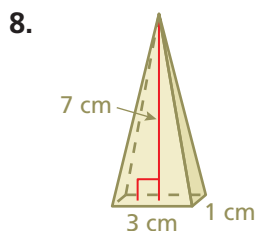
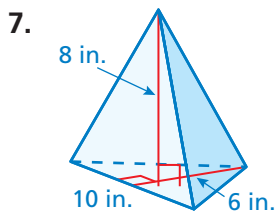
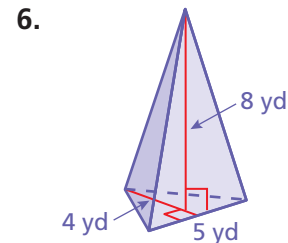
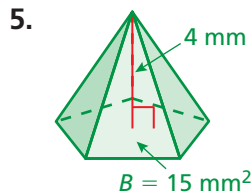
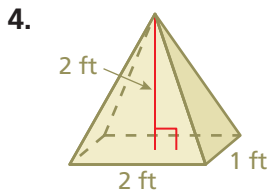

12. **PARACHUTE** In 1483, Leonardo da Vinci designed a parachute. It is believed that this was the first parachute ever designed. In a notebook, he wrote, "If a man is provided with a length of gummed linen cloth with a length of 12 yards on each side and 12 yards high, he can jump from any great height whatsoever without injury." Find the volume of air inside Leonardo's parachute.

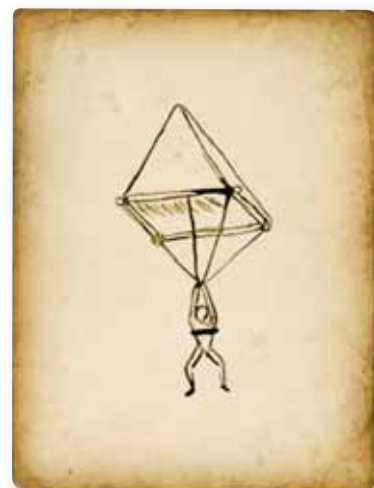

Not drawn to scale

Find the volume of the composite solid.

13.

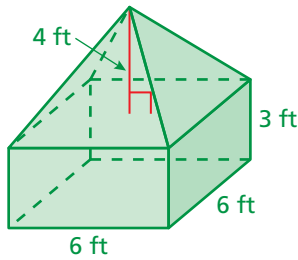

14.

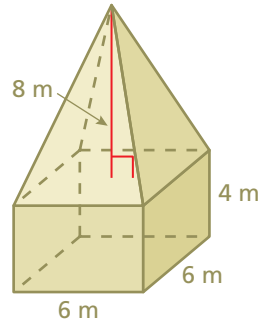

15.

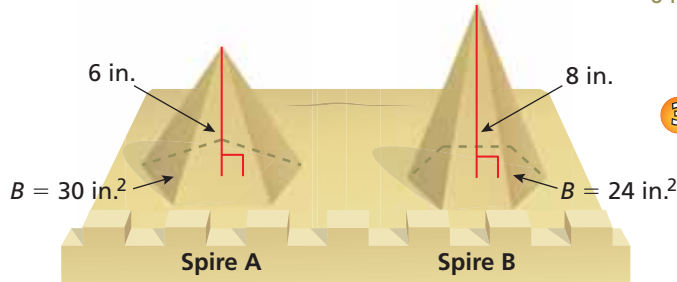
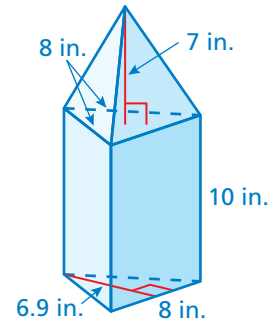

- 3 16. **SPIRE** Which sand-castle spire has a greater volume? How much more sand do you need to make the spire with the greater volume?

17. **PAPERWEIGHT** How much glass is needed to manufacture 1000 paperweights? Explain your reasoning.

18. **PROBLEM SOLVING** Use the photo of the tepee.

- What is the shape of the base? How can you tell?
- The tepee's height is about 10 feet. Estimate the volume of the tepee.

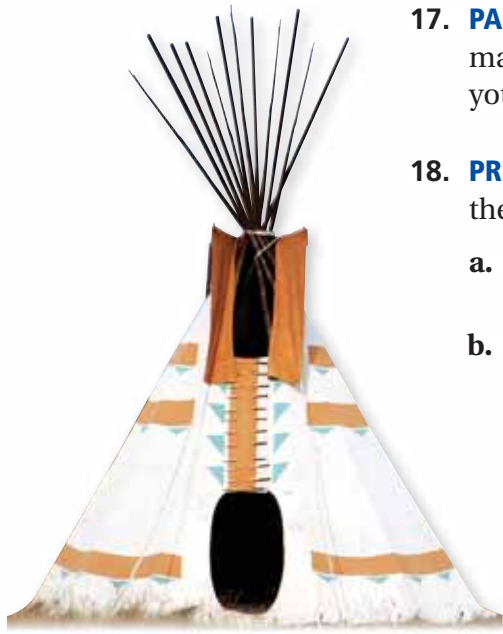
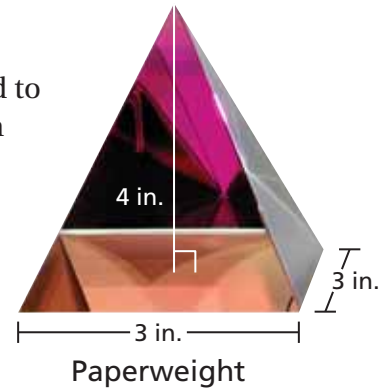

19. **OPEN-ENDED** A pyramid has a volume of 40 cubic feet and a height of 6 feet. Find one possible set of dimensions of the rectangular base.

20. **Reasoning** Do the two solids have the same volume? Explain.

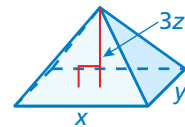
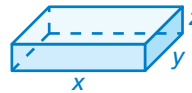

Fair Game Review What you learned in previous grades & lessons

For the given angle measure, find the measure of a supplementary angle and the measure of a complementary angle, if possible. (Section 7.2)

21. 27°

22. 82°

23. 120°

24. **MULTIPLE CHOICE** The circumference of a circle is 44 inches. Which estimate is closest to the area of the circle? (Section 8.3)

(A) 7 in.^2

(B) 14 in.^2

(C) 154 in.^2

(D) 484 in.^2

Extension 9.5 Cross Sections of Three-Dimensional Figures

Key Vocabulary

cross section, p. 388

Consider a plane “slicing” through a solid. The intersection of the plane and the solid is a two-dimensional shape called a **cross section**. For example, the diagram shows that the intersection of the plane and the rectangular prism is a rectangle.

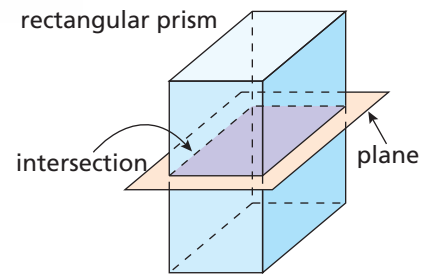

EXAMPLE 1 Describing the Intersection of a Plane and a Solid

Describe the intersection of the plane and the solid.

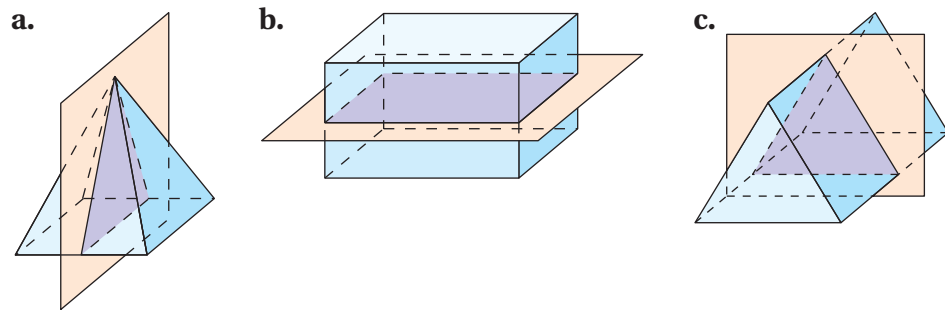

- The intersection is a triangle.
- The intersection is a rectangle.
- The intersection is a triangle.

Geometry

In this extension, you will

- describe the intersections of planes and solids.

Practice

Describe the intersection of the plane and the solid.

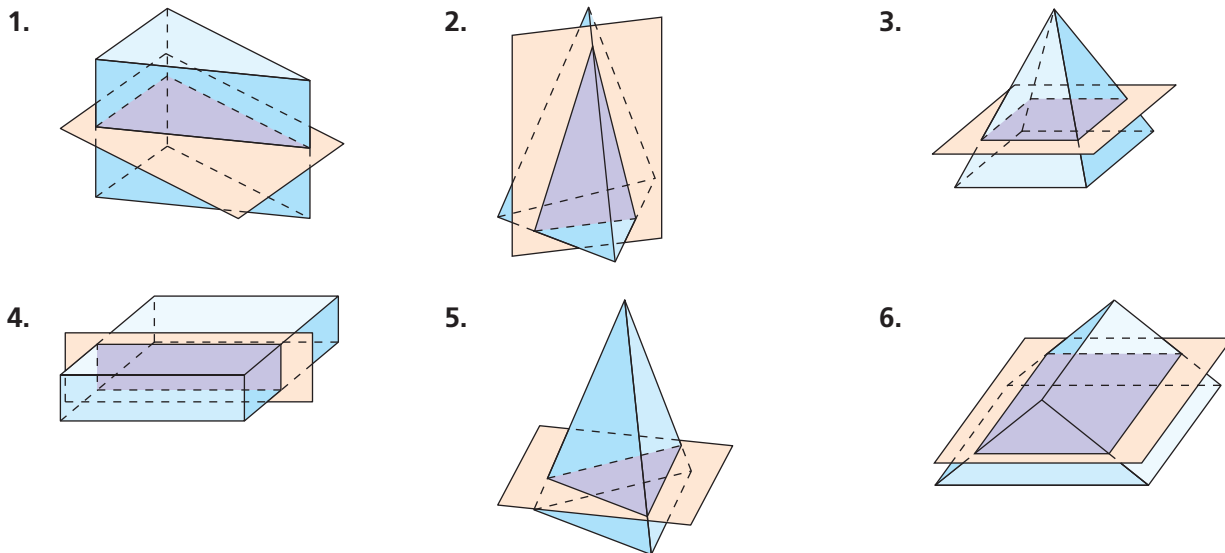

- REASONING** A plane that intersects a prism is parallel to the bases of the prism. Describe the intersection of the plane and the prism.

Example 1 shows how a plane intersects a polyhedron. Now consider the intersection of a plane and a solid having a curved surface, such as a cylinder or cone. As shown, a *cone* is a solid that has one circular base and one vertex.

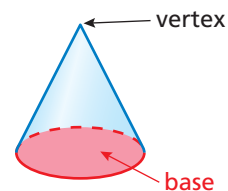

EXAMPLE 2 Describing the Intersection of a Plane and a Solid

Math Practice

Analyze Givens

What solid is shown? What are you trying to find? Explain.

Describe the intersection of the plane and the solid.

a.

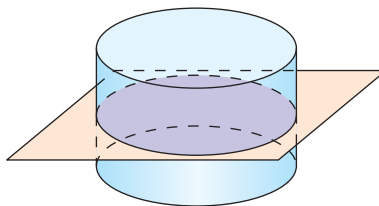

b.

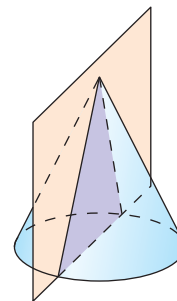

- a. The intersection is a circle.
- b. The intersection is a triangle.

Practice

Describe the intersection of the plane and the solid.

8.

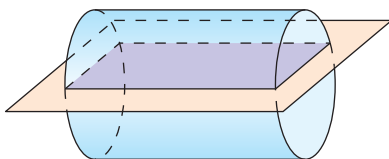

9.

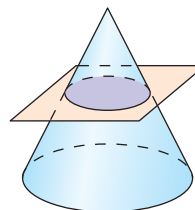

10.

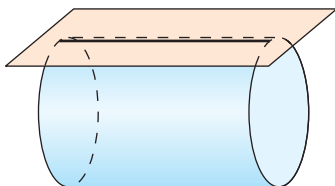

11.

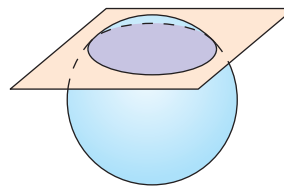

Describe the shape that is formed by the cut made in the food shown.

12.



13.



14.



15. **REASONING** Explain how a plane can be parallel to the base of a cone and intersect the cone at exactly one point.

Find the volume of the prism. (Section 9.4)

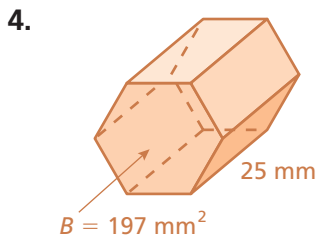
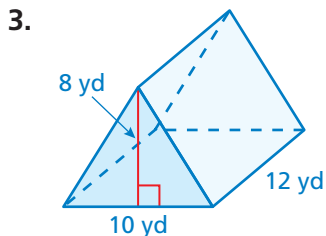
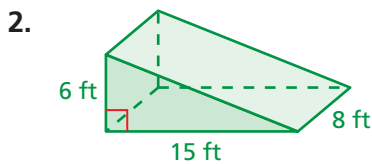
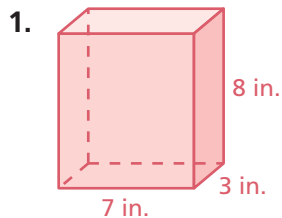

Find the volume of the solid. Round your answer to the nearest tenth if necessary. (Section 9.5)

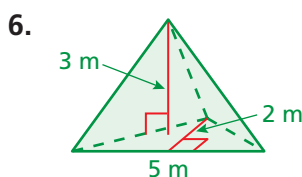
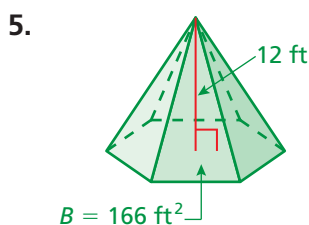

Describe the intersection of the plane and the solid. (Section 9.5)

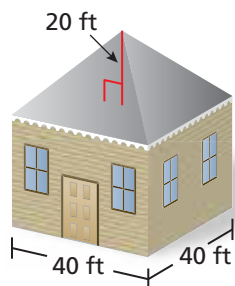
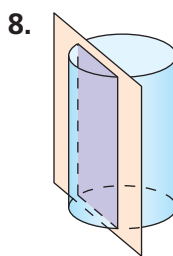
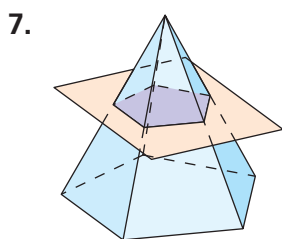

9. **ROOF** A pyramid hip roof is a good choice for a house in a hurricane area. What is the volume of the roof to the nearest tenth? (Section 9.5)

10. **CUBIC UNITS** How many cubic feet are in a cubic yard? Use a sketch to explain your reasoning. (Section 9.4)

Review Key Vocabulary

lateral surface area, p. 358
regular pyramid, p. 364

slant height, p. 364
cross section, p. 388

Review Examples and Exercises

9.1 Surface Areas of Prisms (pp. 354–361)

Find the surface area of the prism.

Draw a net.

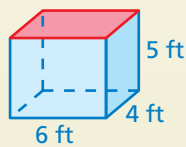

$$\begin{aligned} S &= 2lw + 2lh + 2wh \\ &= 2(6)(4) + 2(6)(5) + 2(4)(5) \\ &= 48 + 60 + 40 \\ &= 148 \end{aligned}$$

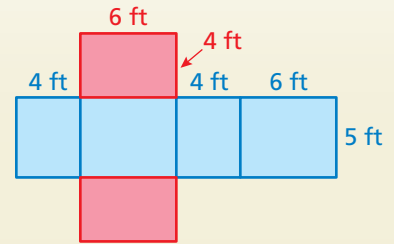

∴ The surface area is 148 square feet.

Exercises

Find the surface area of the prism.

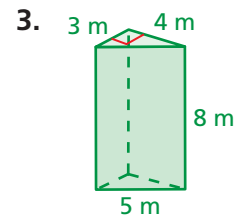
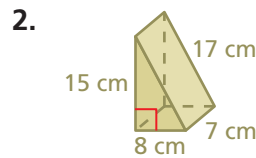
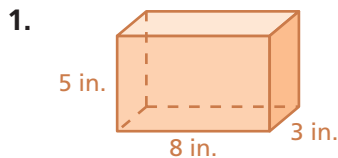

9.2 Surface Areas of Pyramids (pp. 362–367)

Find the surface area of the regular pyramid.

Draw a net.

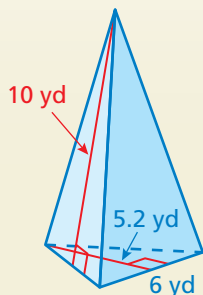

Area of Base

$$\frac{1}{2} \cdot 6 \cdot 5.2 = 15.6$$

Area of a Lateral Face

$$\frac{1}{2} \cdot 6 \cdot 10 = 30$$

Find the sum of the areas of the base and all three lateral faces.

$$\begin{aligned} S &= 15.6 + 30 + 30 + 30 \\ &= 105.6 \end{aligned}$$

There are 3 identical lateral faces. Count the area 3 times.

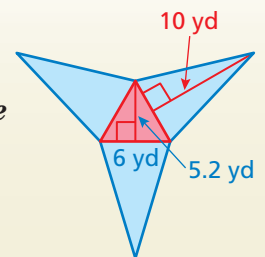

∴ The surface area is 105.6 square yards.

Exercises

Find the surface area of the regular pyramid.

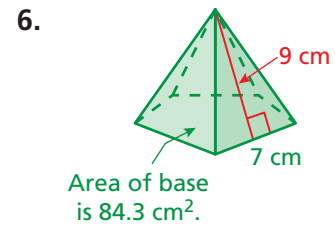
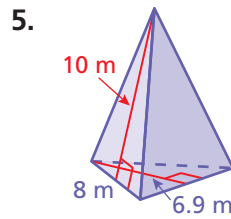
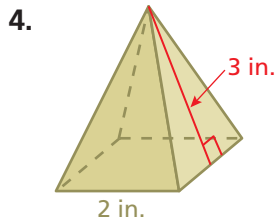

9.3 Surface Areas of Cylinders (pp. 368–373)

Find the surface area of the cylinder. Round your answer to the nearest tenth.

Draw a net.

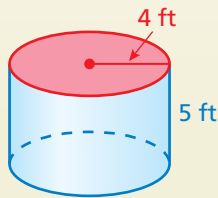

$$\begin{aligned} S &= 2\pi r^2 + 2\pi r h \\ &= 2\pi(4)^2 + 2\pi(4)(5) \\ &= 32\pi + 40\pi \\ &= 72\pi \approx 226.1 \end{aligned}$$

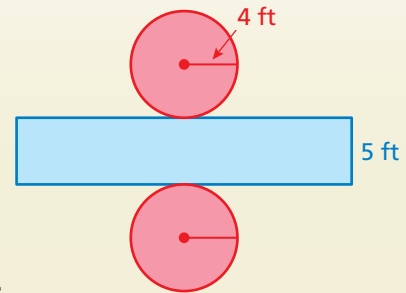

∴ The surface area is about 226.1 square millimeters.

Exercises

Find the surface area of the cylinder. Round your answer to the nearest tenth.

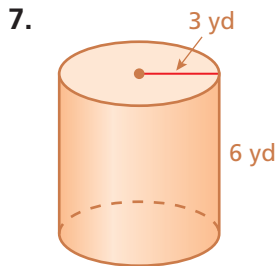

9. **ORANGES** Find the lateral surface area of the can of mandarin oranges.



9.4 Volumes of Prisms (pp. 376–381)

Find the volume of the prism.

$$\begin{aligned} V &= Bh && \text{Write formula for volume.} \\ &= \frac{1}{2}(7)(3) \cdot 5 && \text{Substitute.} \\ &= 52.5 && \text{Multiply.} \end{aligned}$$

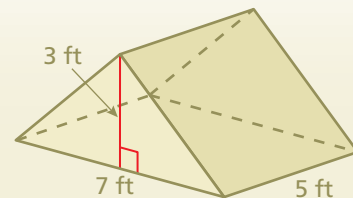

∴ The volume is 52.5 cubic feet.

Exercises

Find the volume of the prism.

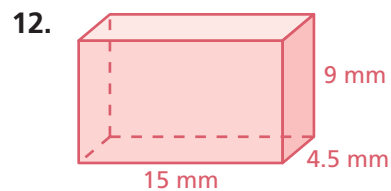
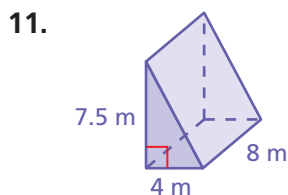
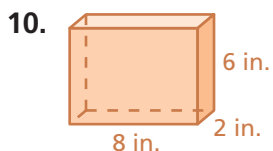

9.5 Volumes of Pyramids (pp. 382–389)

a. Find the volume of the pyramid.

$$V = \frac{1}{3}Bh$$

Write formula for volume.

$$= \frac{1}{3}(6)(5)(10)$$

Substitute.

$$= 100$$

Multiply.

∴ The volume is 100 cubic yards.

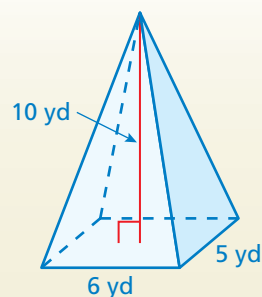

b. Describe the intersection of the plane and the solid.

i.

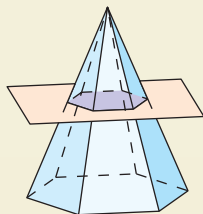

The intersection is a hexagon.

ii.

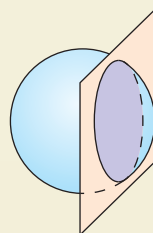

The intersection is a circle.

Exercises

Find the volume of the pyramid.

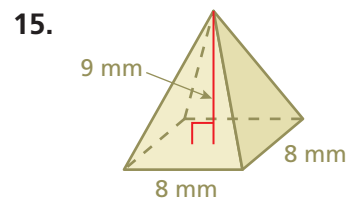
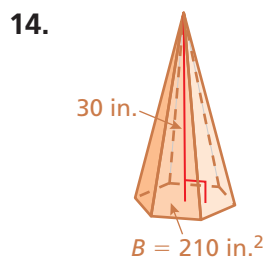
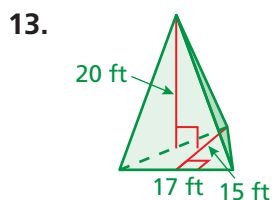

Describe the intersection of the plane and the solid.

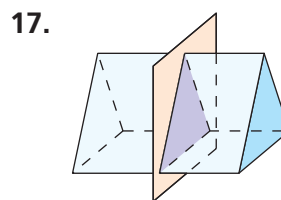
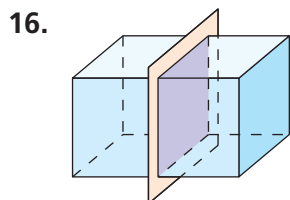

9 Chapter Test

Check It Out
Test Practice
BigIdeasMath.com

Find the surface area of the prism or regular pyramid.

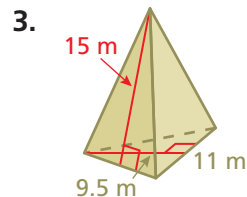
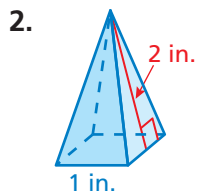
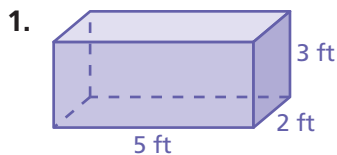

Find the surface area of the cylinder. Round your answer to the nearest tenth.

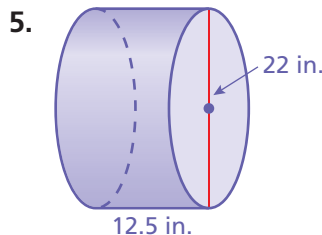
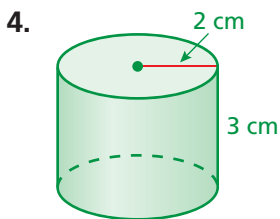

Find the volume of the solid.

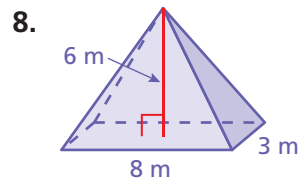
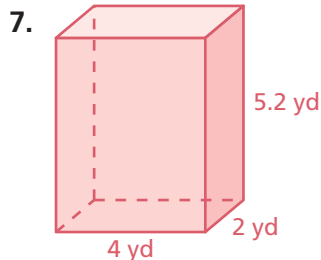
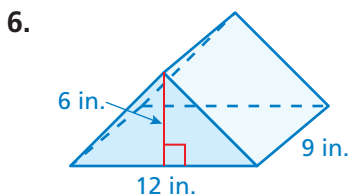

9. **SKATEBOARD RAMP** A quart of paint covers 80 square feet. How many quarts should you buy to paint the ramp with two coats? (Assume you will not paint the bottom of the ramp.)

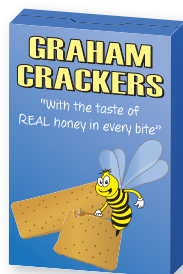
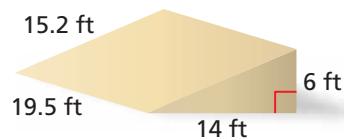

$h = 9$ in.

$l = 6$ in. $w = 2$ in.

10. **GRAHAM CRACKERS** A manufacturer wants to double the volume of the graham cracker box. The manufacturer will either double the height or double the width.
- Which option uses less cardboard? Justify your answer.
 - What is the volume of the new graham cracker box?

11. **SOUP** The label on the can of soup covers about 354.2 square centimeters. What is the height of the can? Round your answer to the nearest whole number.



9 Cumulative Assessment

1. A gift box and its dimensions are shown below.



What is the least amount of wrapping paper that you could have used to wrap the box?

- A. 20 in.^2 C. 64 in.^2
 B. 56 in.^2 D. 112 in.^2
2. A student scored 600 the first time she took the mathematics portion of her college entrance exam. The next time she took the exam, she scored 660. Her second score represents what percent increase over her first score?
- F. 9.1% H. 39.6%
 G. 10% I. 60%
3. Raj was solving the proportion in the box below.

$$\frac{3}{8} = \frac{x-3}{24}$$

$$3 \cdot 24 = (x-3) \cdot 8$$

$$72 = x - 24$$

$$96 = x$$

What should Raj do to correct the error that he made?

- A. Set the product of the numerators equal to the product of the denominators.
 B. Distribute 8 to get $8x - 24$.
 C. Add 3 to each side to get $\frac{3}{8} + 3 = \frac{x}{24}$.
 D. Divide both sides by 24 to get $\frac{3}{8} \div 24 = x - 3$.

Test-Taking Strategy
After Answering Easy Questions, Relax

Find the surface area.
 (A) 10 ft (C) 10 ft^2
 (B) 10 ft^3 (D) 2 ft^3

“After answering the easy questions, relax and try the harder ones. For this, you know area is measured in square units.”

8. A rectangular prism and its dimensions are shown below.

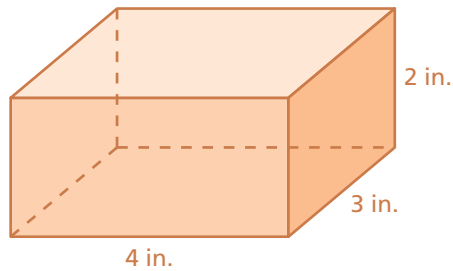

What is the volume, in cubic inches, of a rectangular prism whose dimensions are three times greater?

9. What is the value of x ?

A. 20

B. 43

C. 44

D. 65

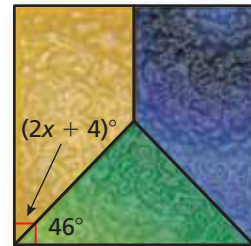

10. Which of the following could be the angle measures of a triangle?

F. $60^\circ, 50^\circ, 20^\circ$

H. $30^\circ, 60^\circ, 90^\circ$

G. $40^\circ, 80^\circ, 90^\circ$

I. $0^\circ, 90^\circ, 90^\circ$

11. The table below shows the costs of buying matinee movie tickets.



Matinee Tickets, x	2	3	4	5
Cost, y	\$9	\$13.50	\$18	\$22.50

Part A Graph the data.

Part B Find and interpret the slope of the line through the points.

Part C How much does it cost to buy 8 matinee movie tickets?